

A-Z Letter Formation Tracing

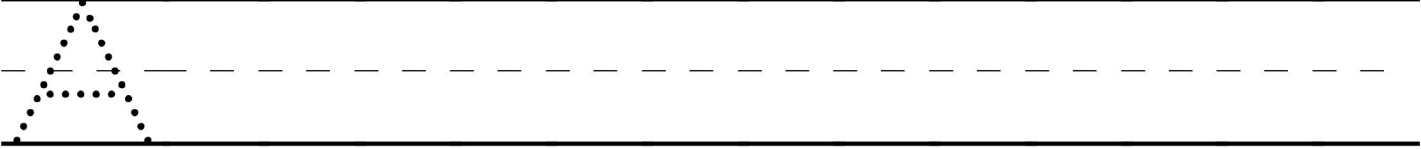

A-Z Letter Formation Tracing

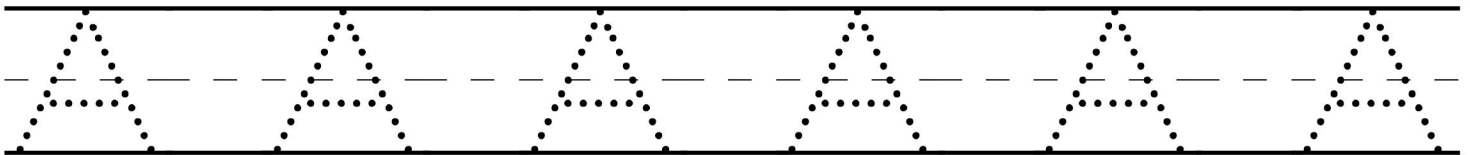
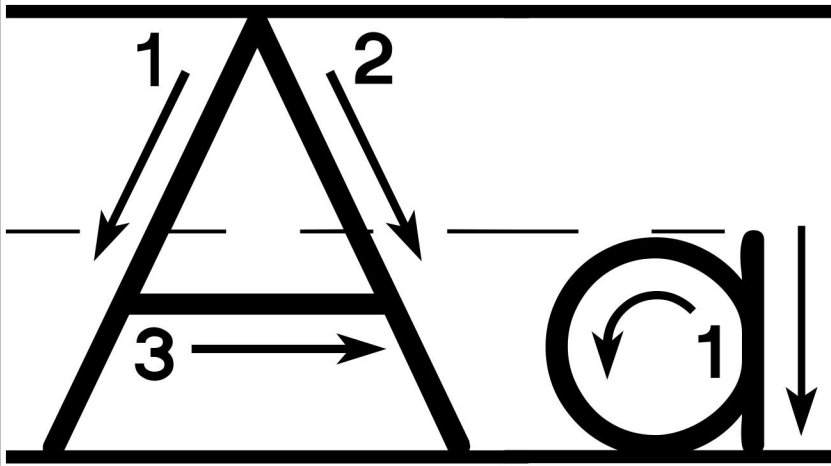
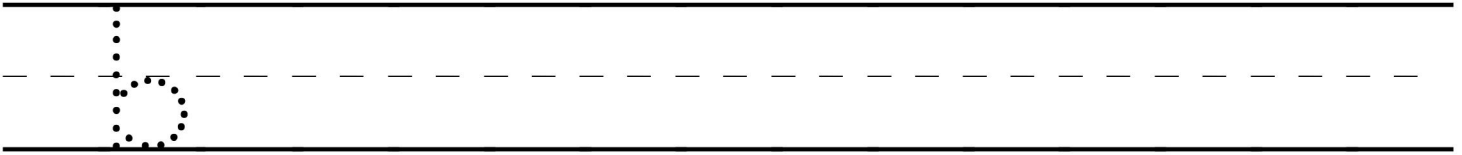
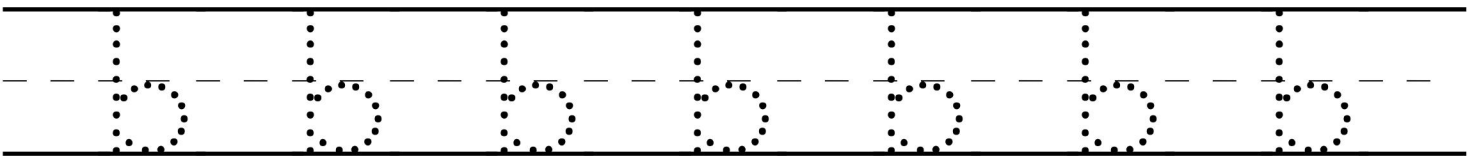
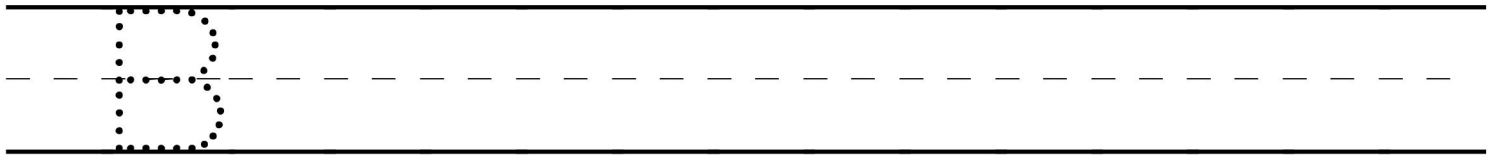
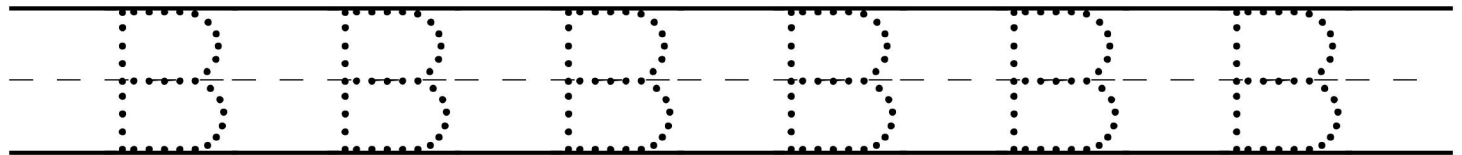
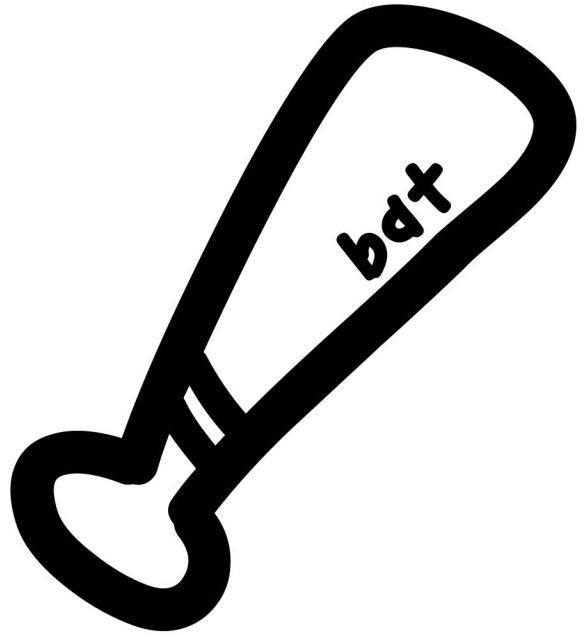
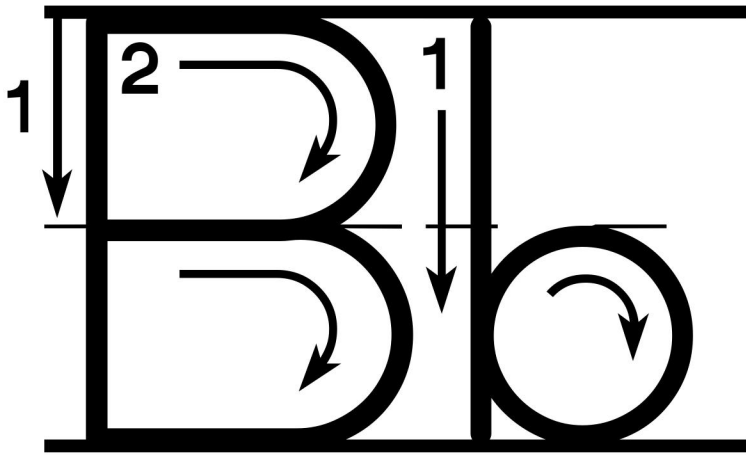

A-Z Letter Formation Tracing

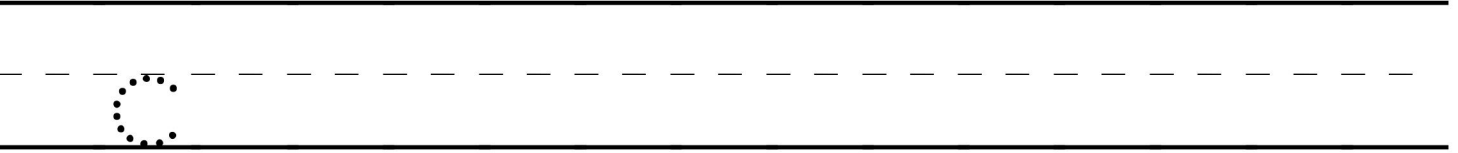
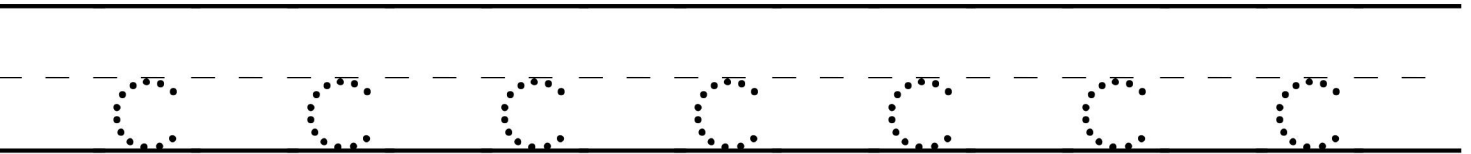
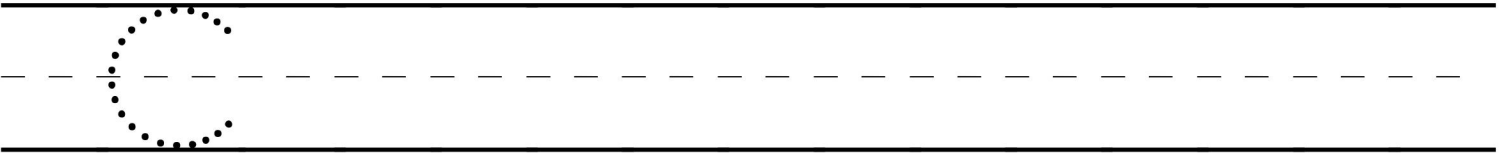
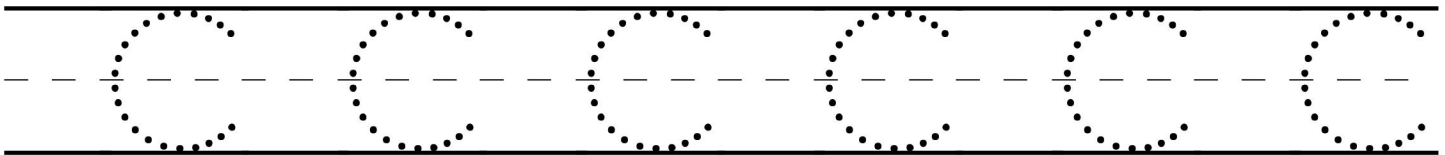
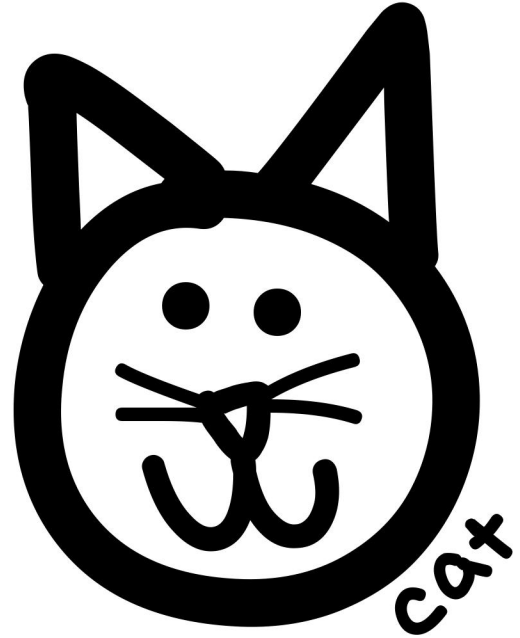
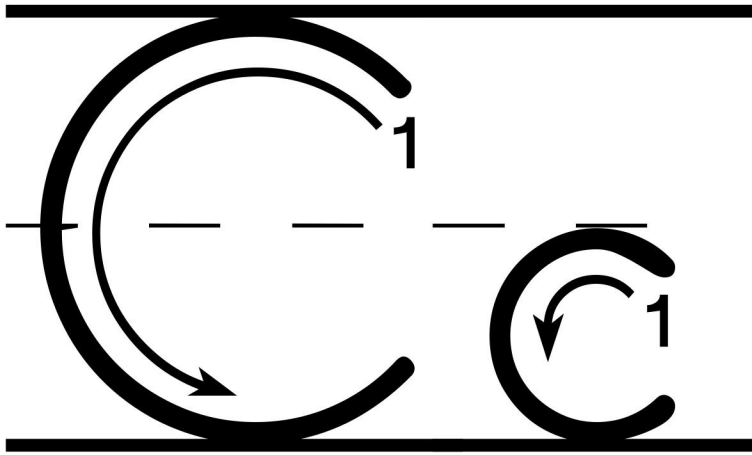

A-Z Letter Formation Tracing

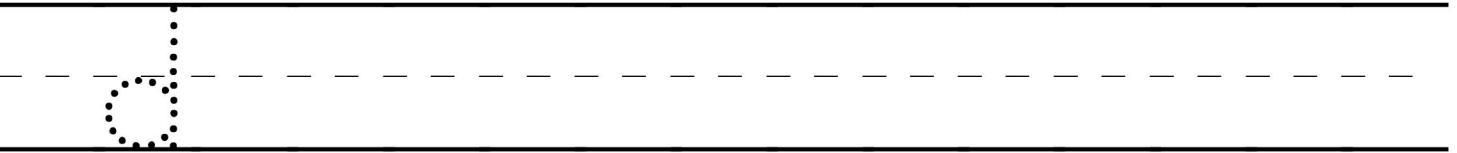
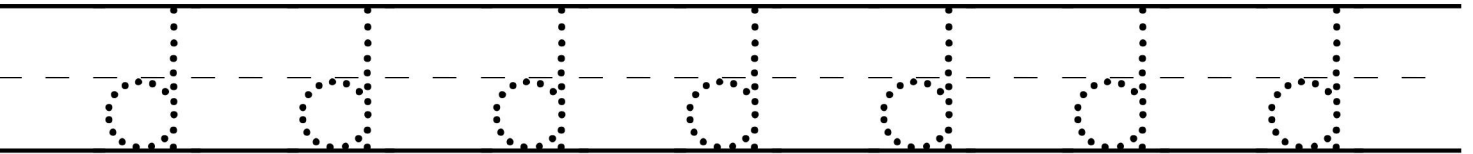
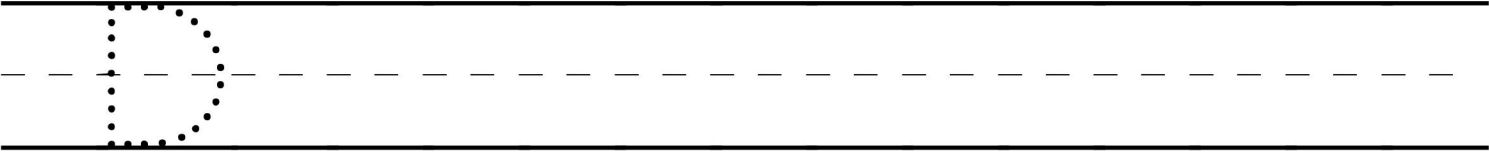
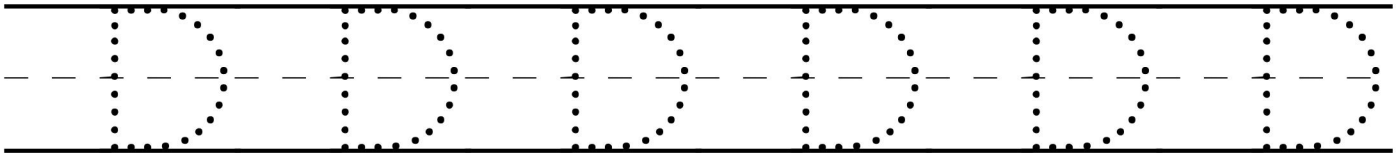
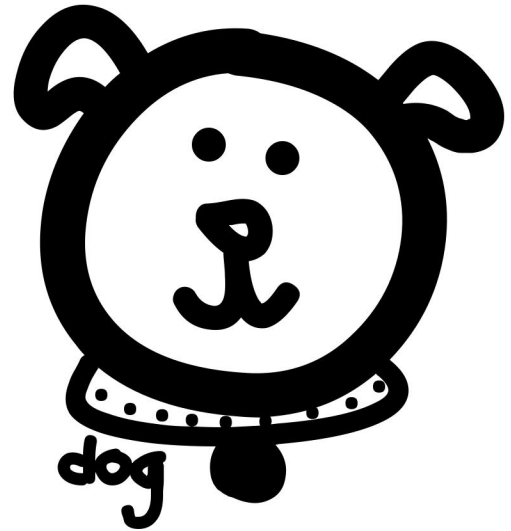
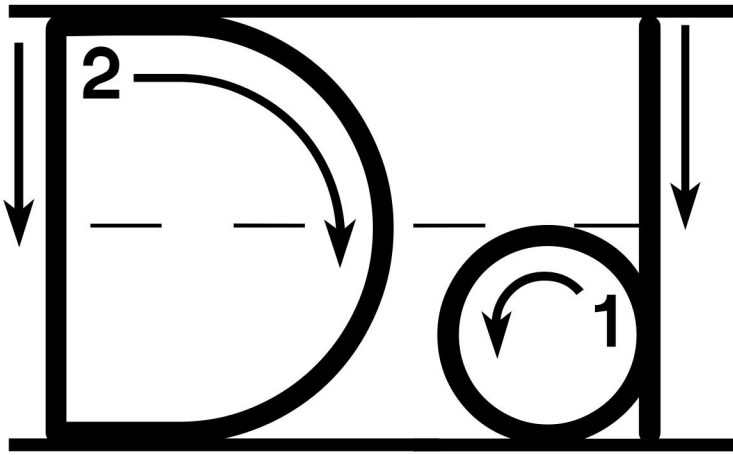

A-Z Letter Formation Tracing

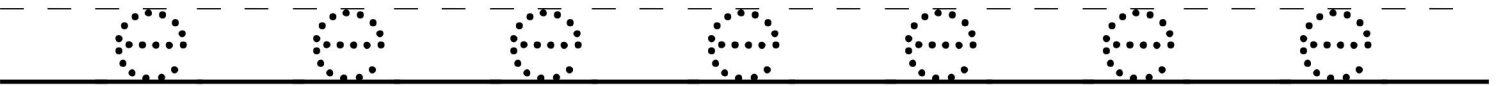
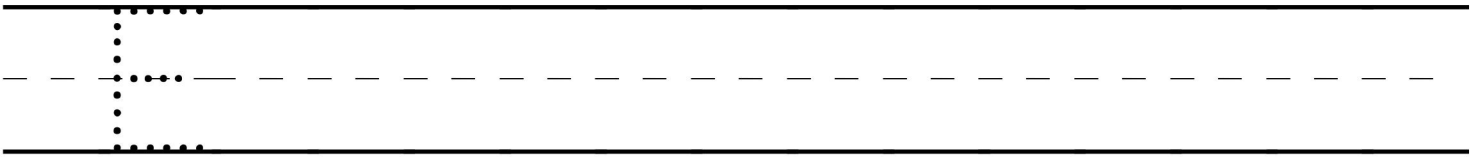
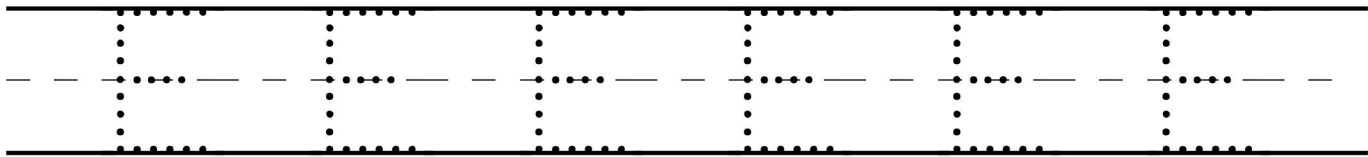
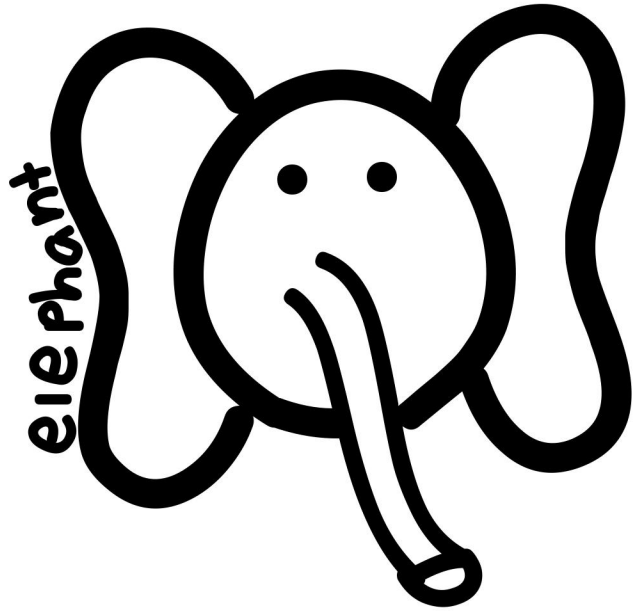
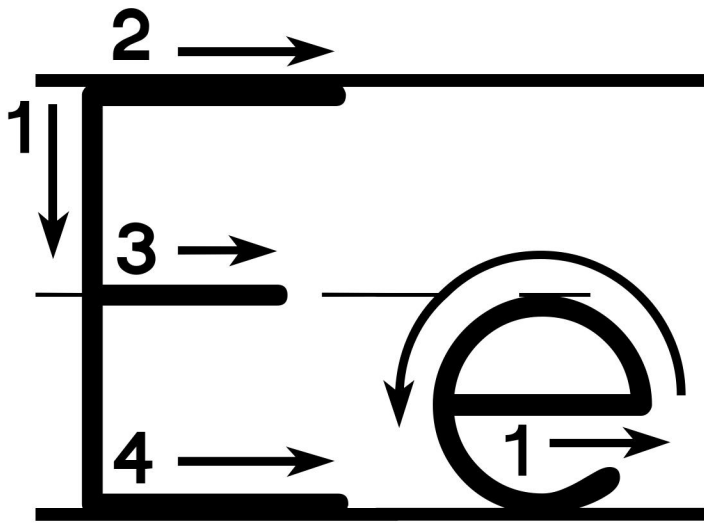

A-Z Letter Formation Tracing

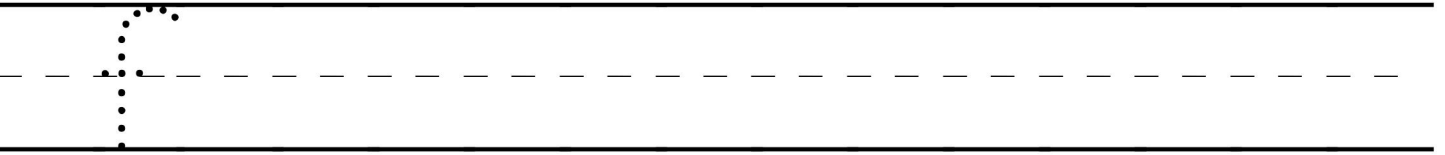
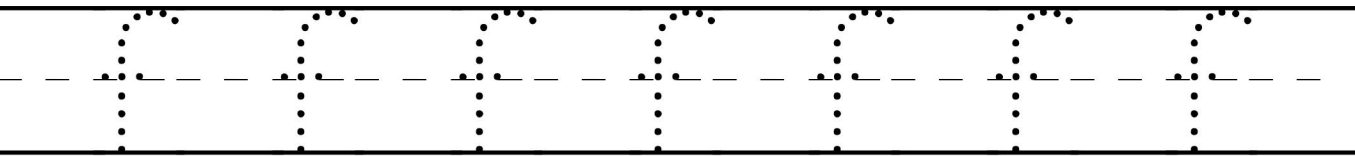
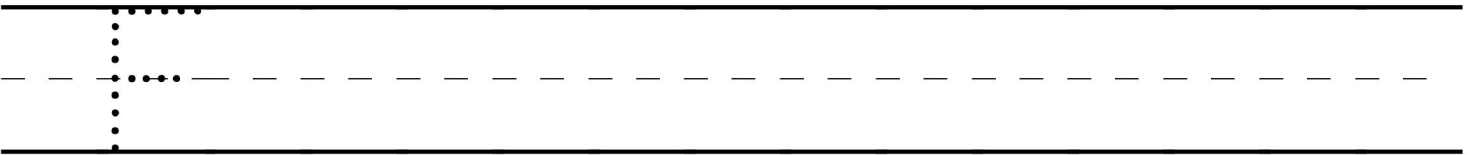
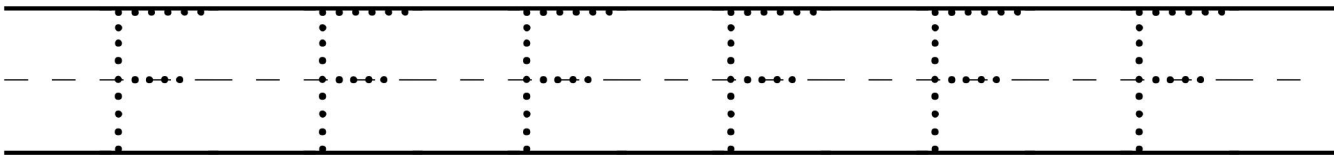
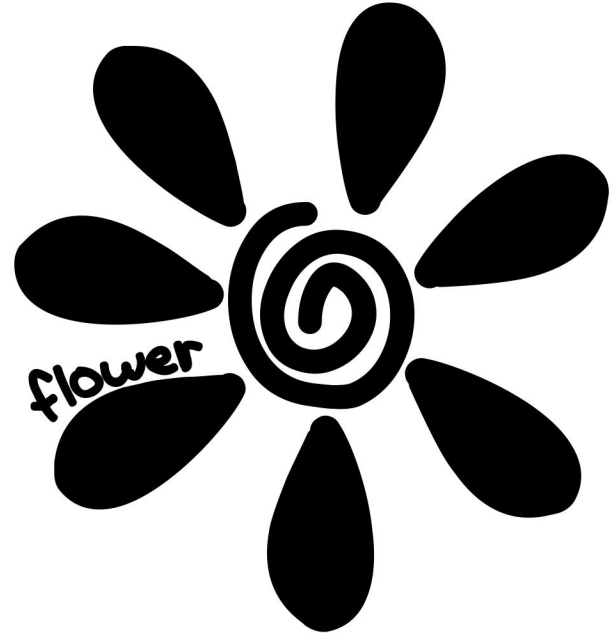
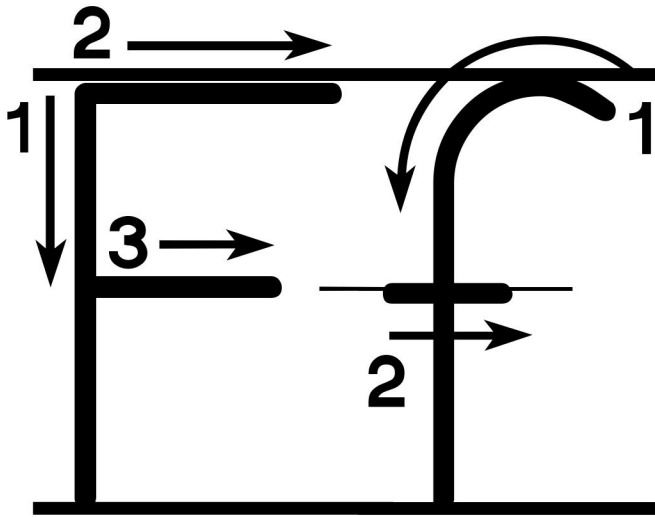

A-Z Letter Formation Tracing

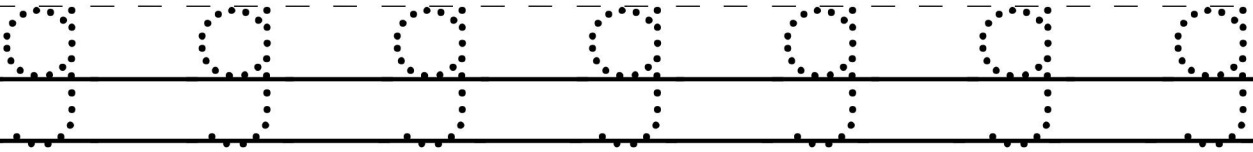
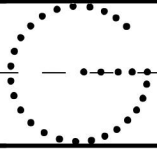
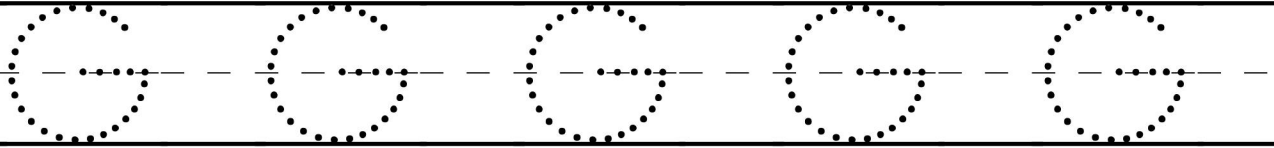
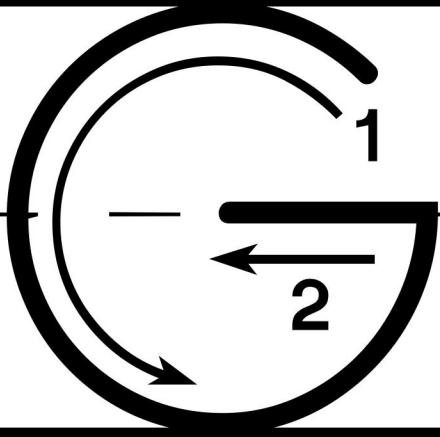

A-Z Letter Formation Tracing

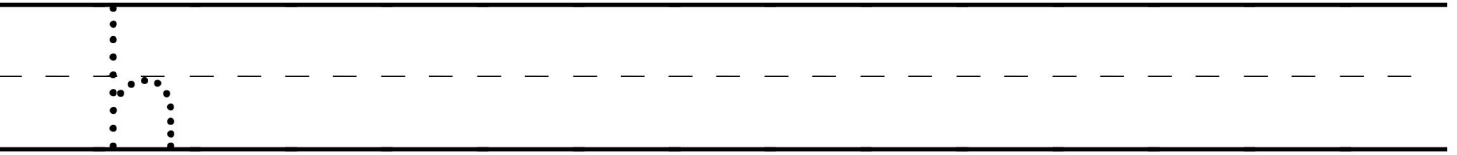
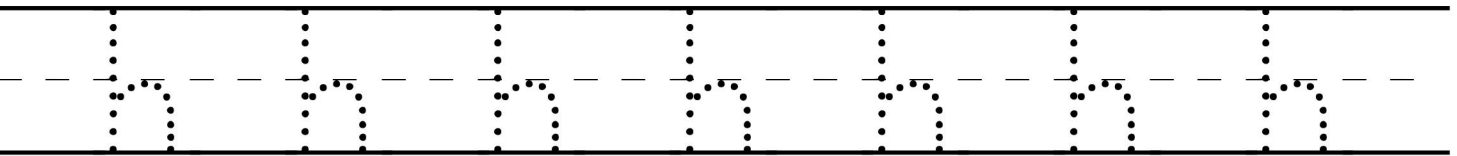
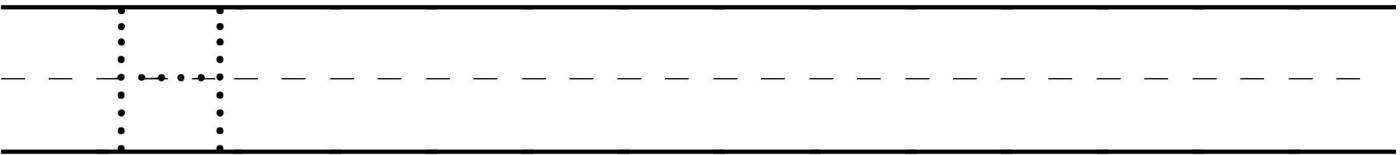
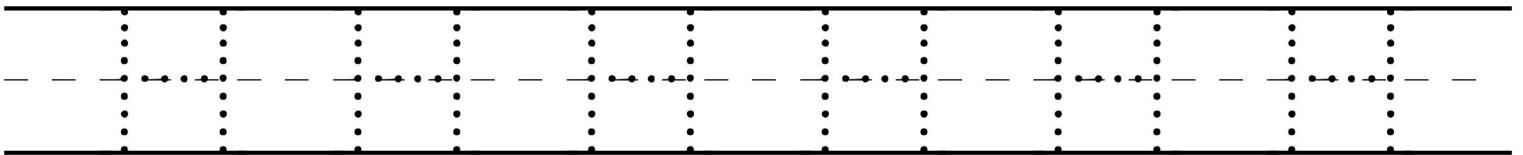
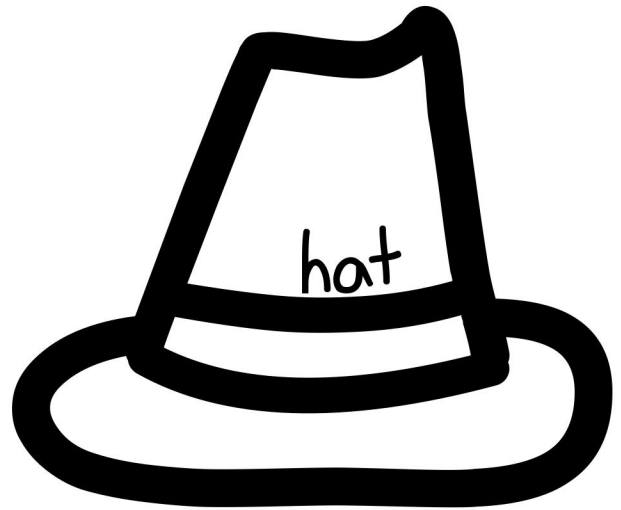
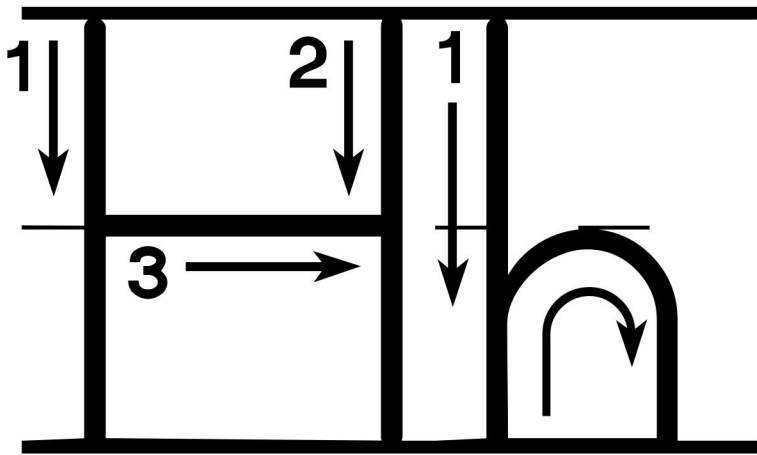

A-Z Letter Formation Tracing

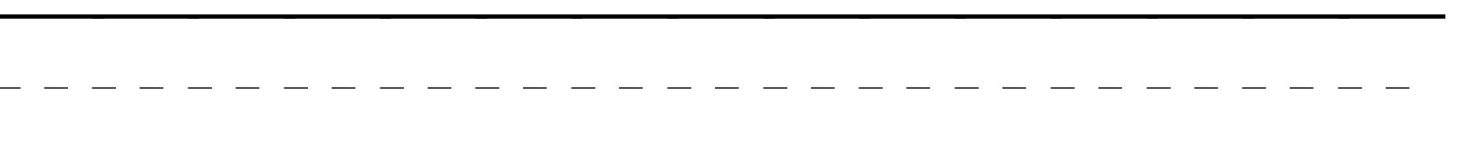
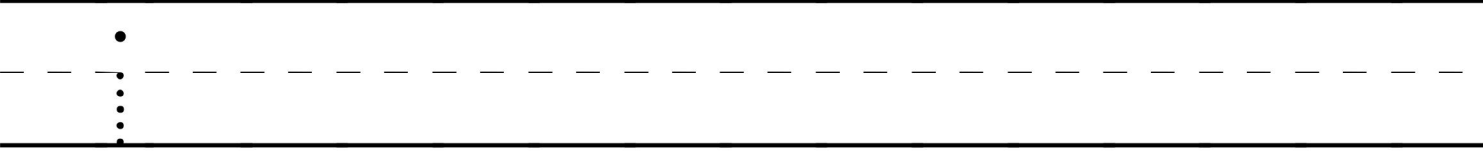
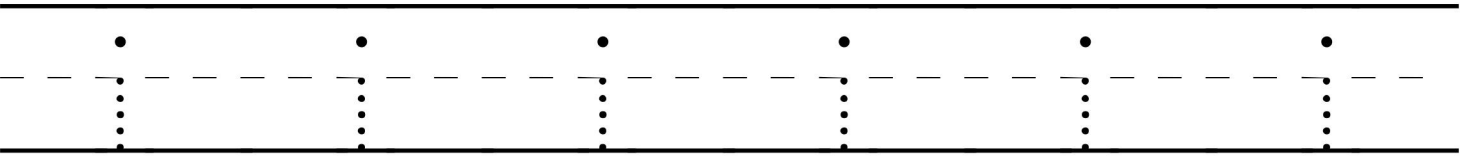
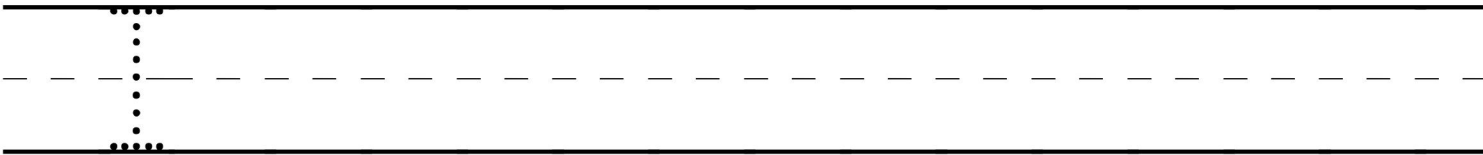
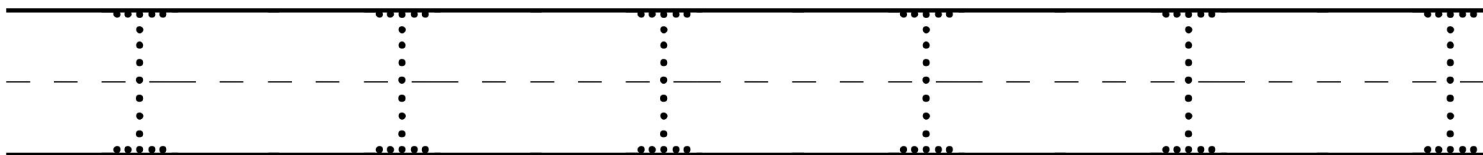
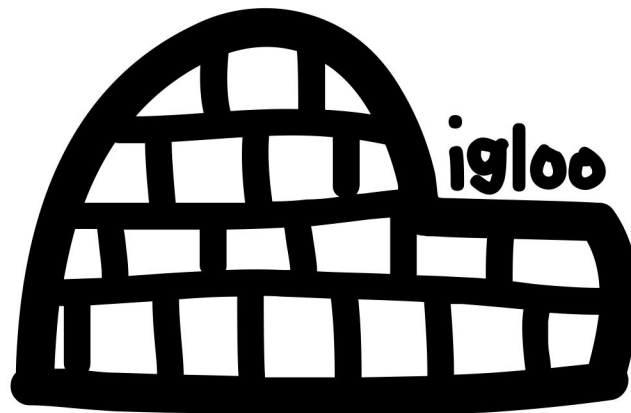
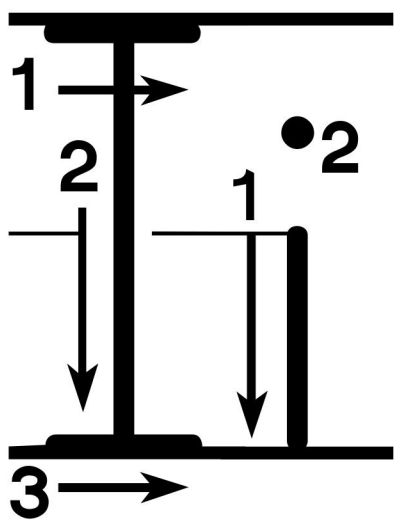

A-Z Letter Formation Tracing

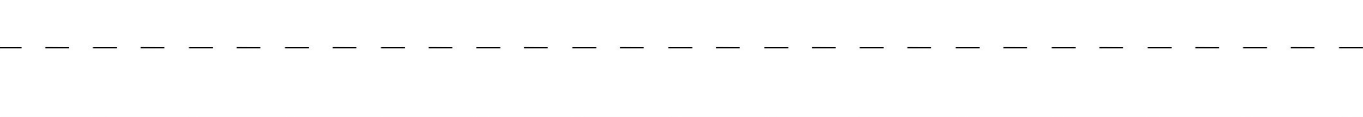
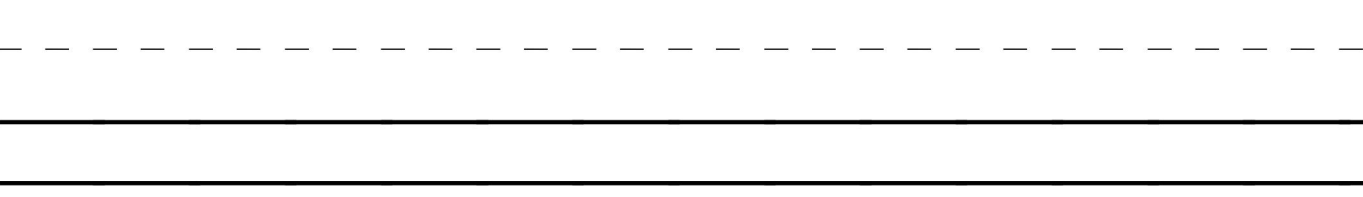
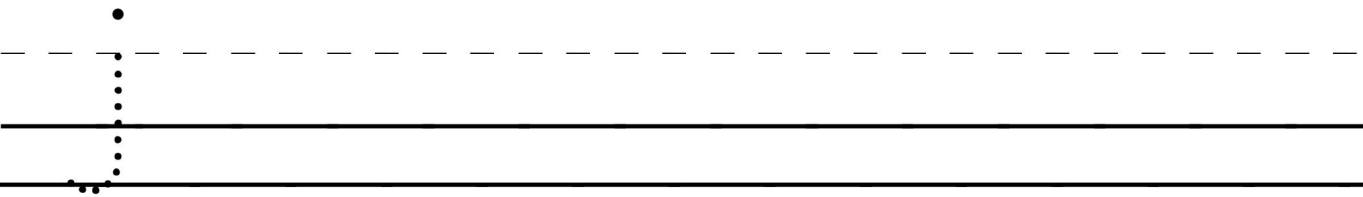
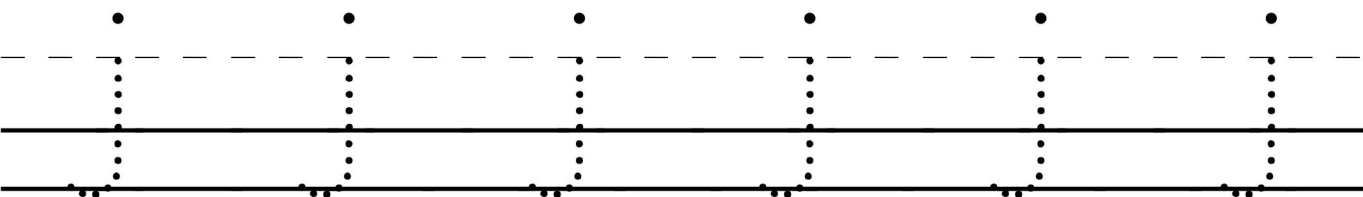
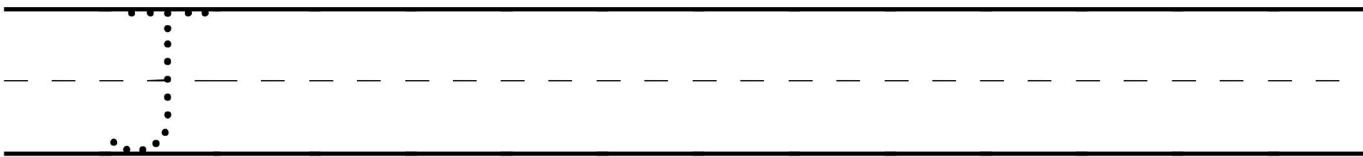
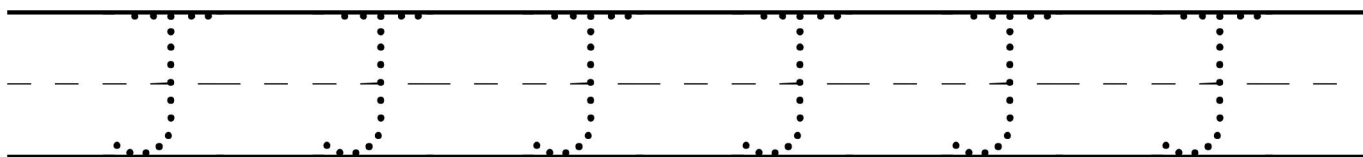
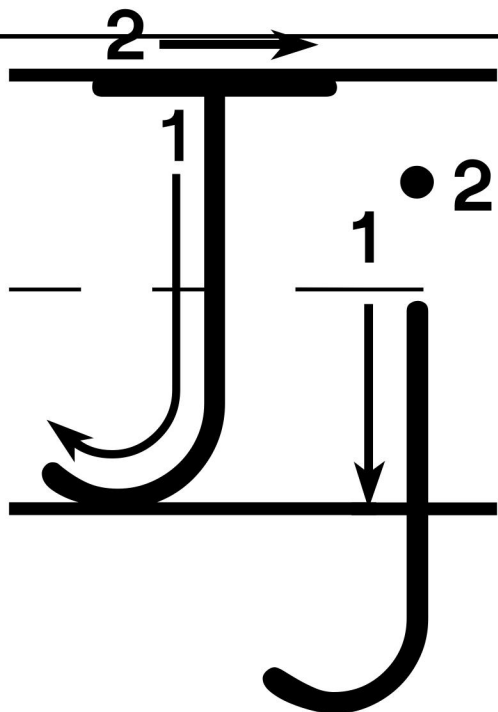

A-Z Letter Formation Tracing

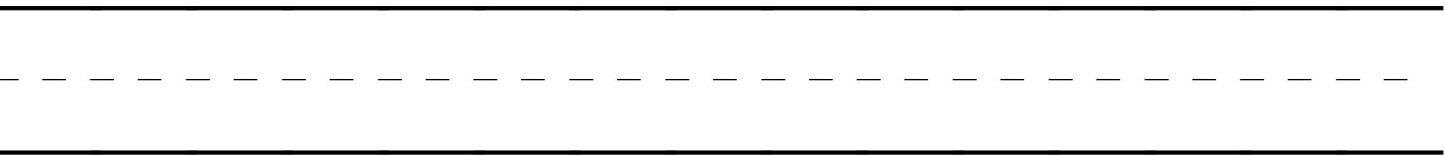
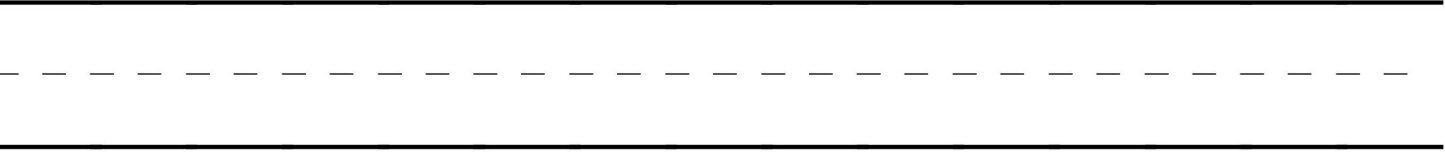
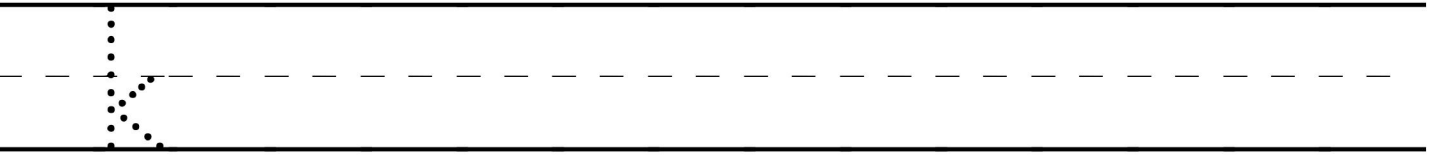
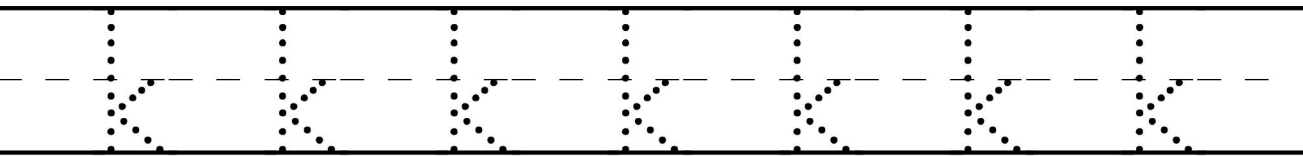
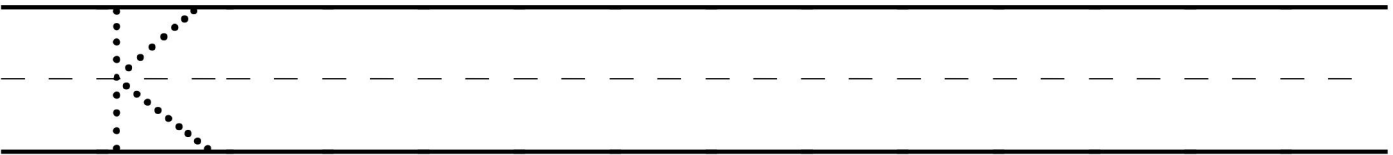
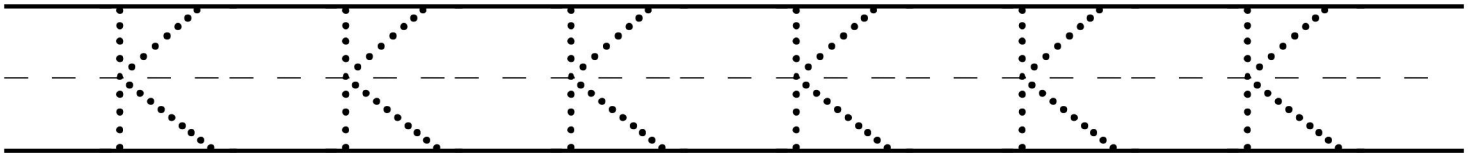
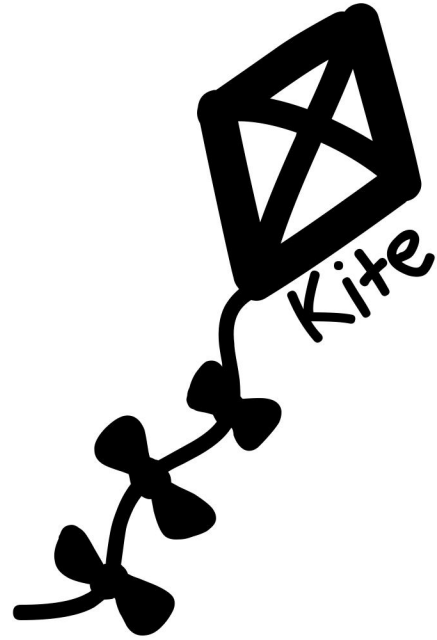
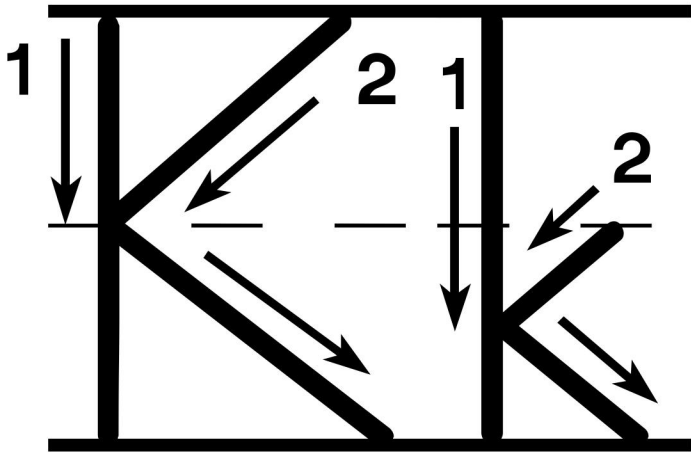

A-Z Letter Formation Tracing

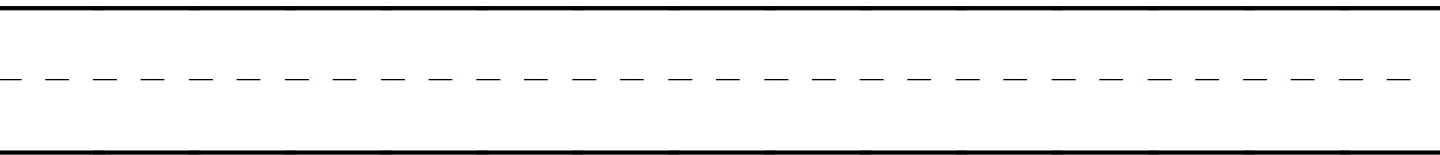
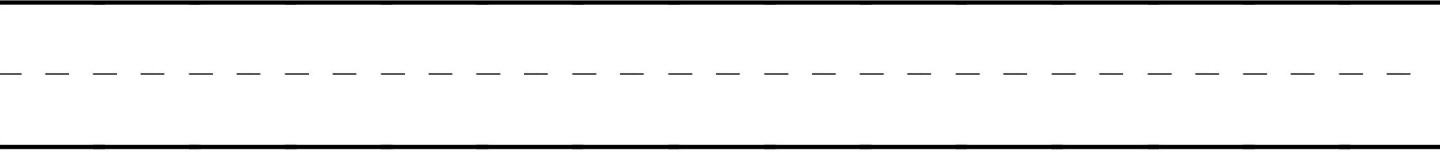
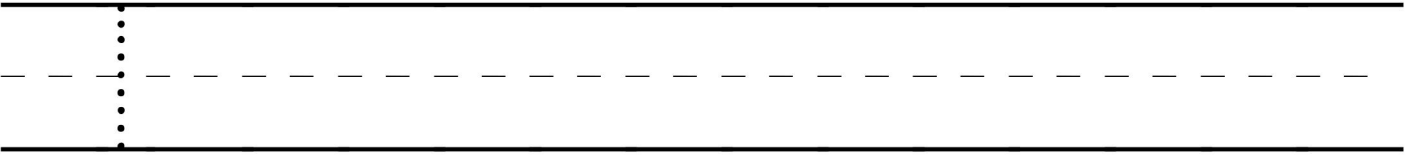
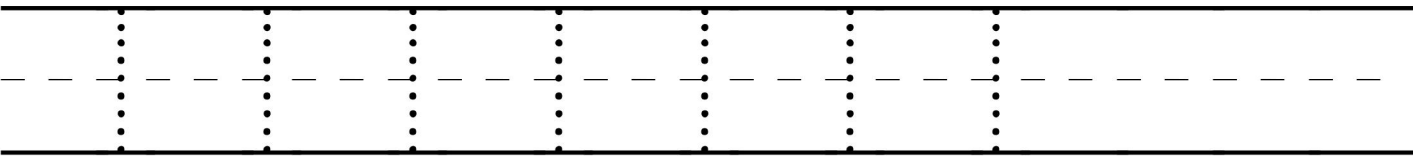
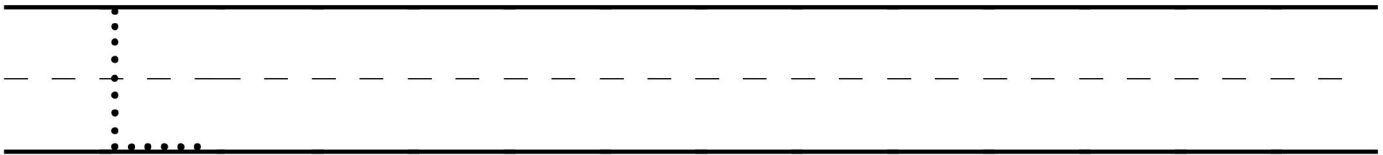
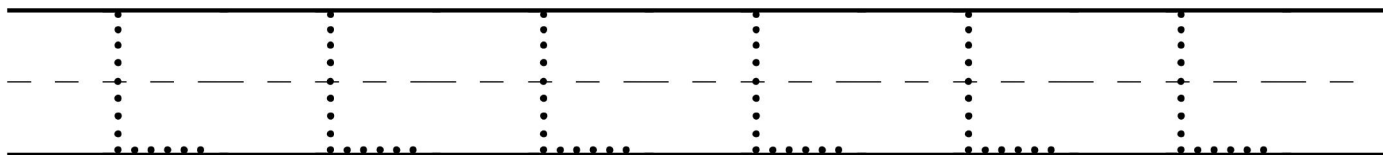
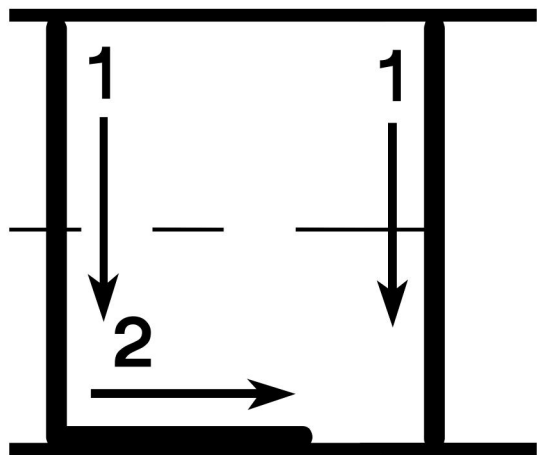

A-Z Letter Formation Tracing

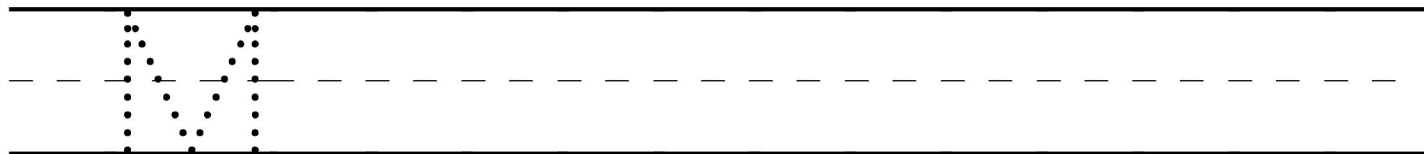
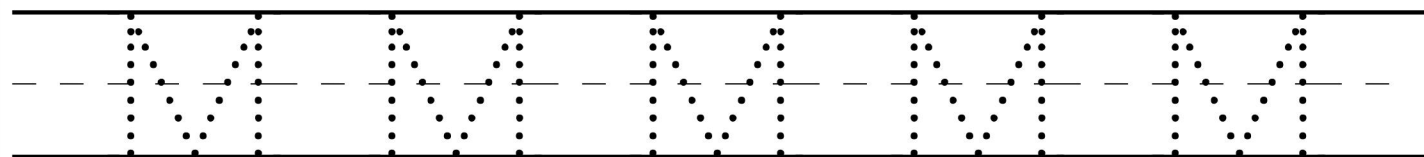
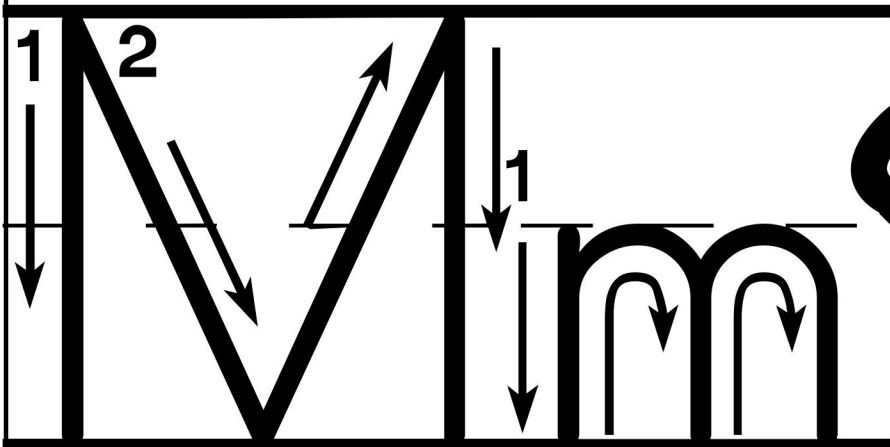

A-Z Letter Formation Tracing

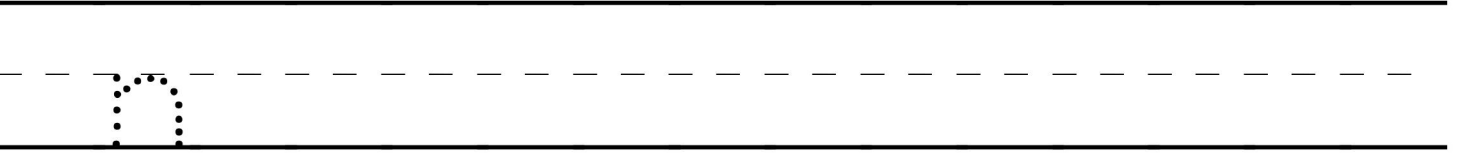
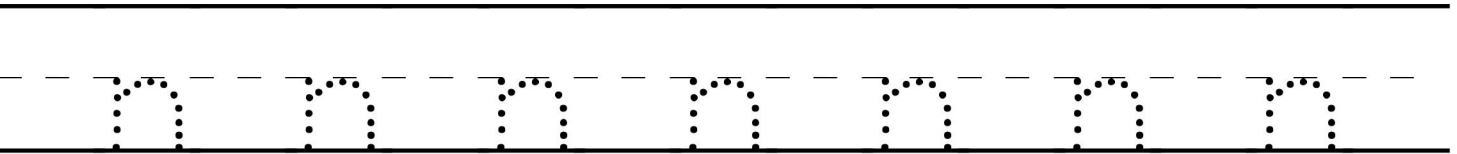
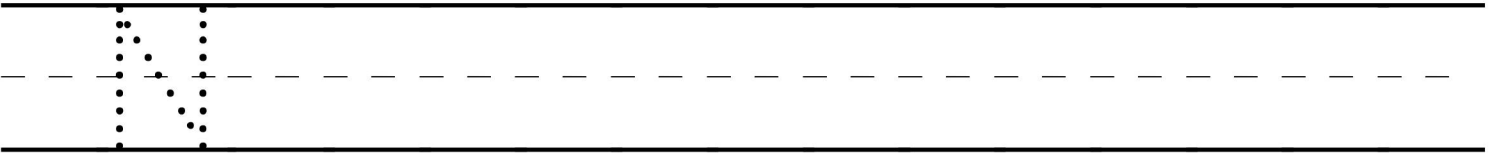
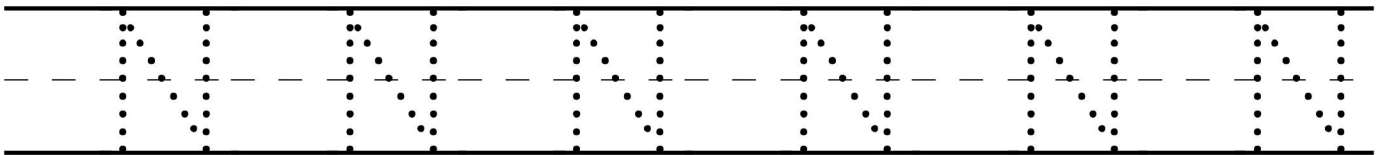
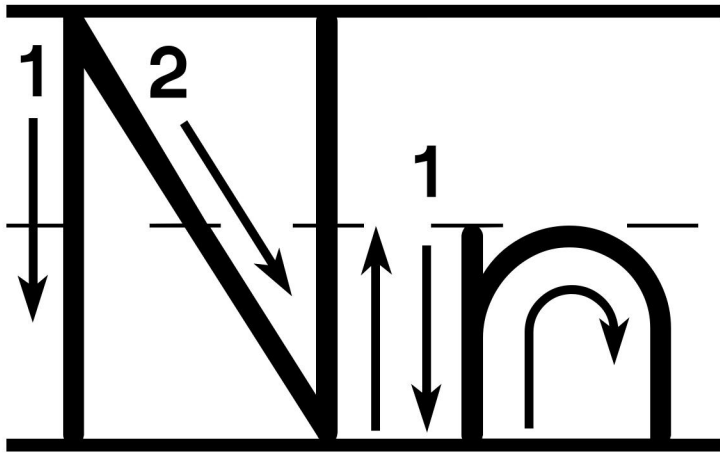

A-Z Letter Formation Tracing

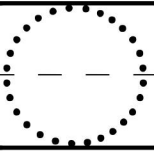
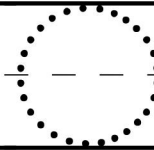
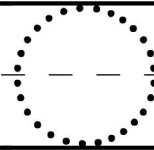
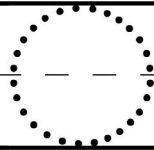
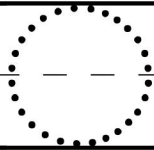
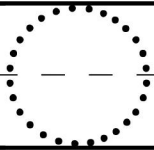
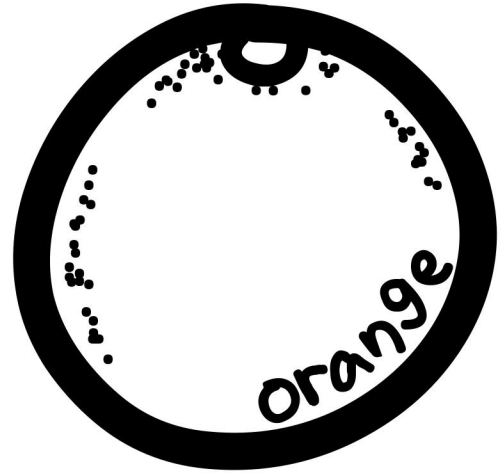
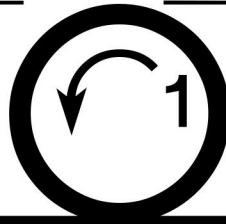
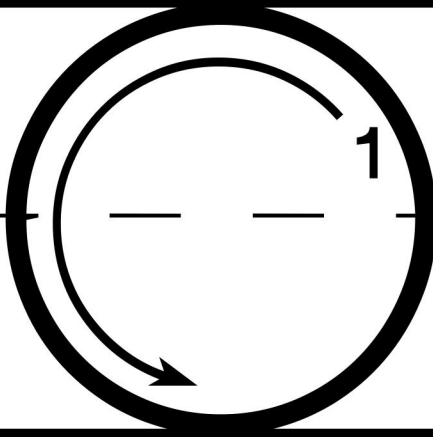

A-Z Letter Formation Tracing

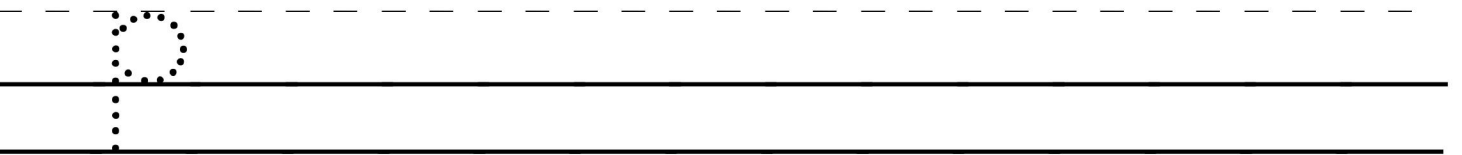
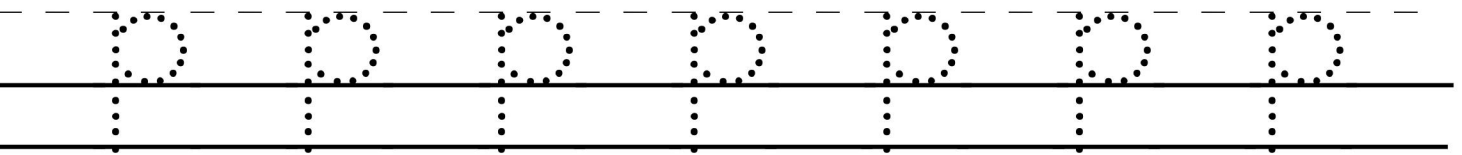
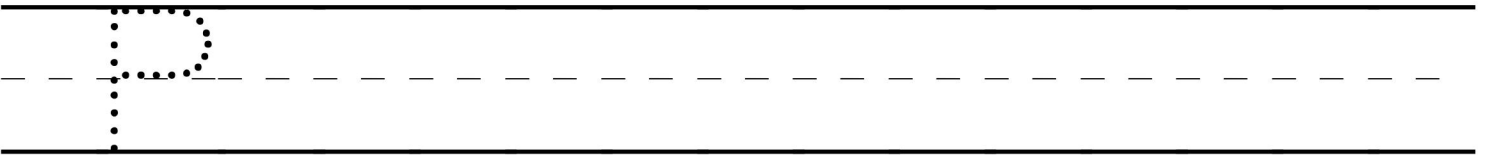
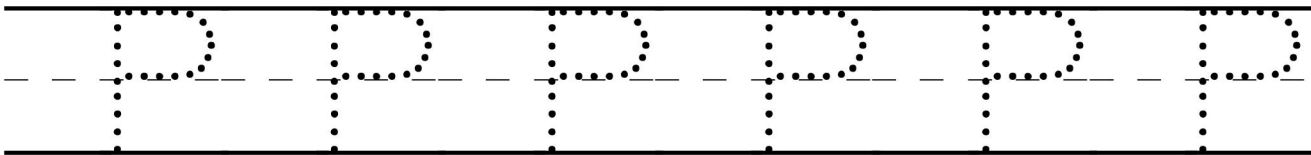
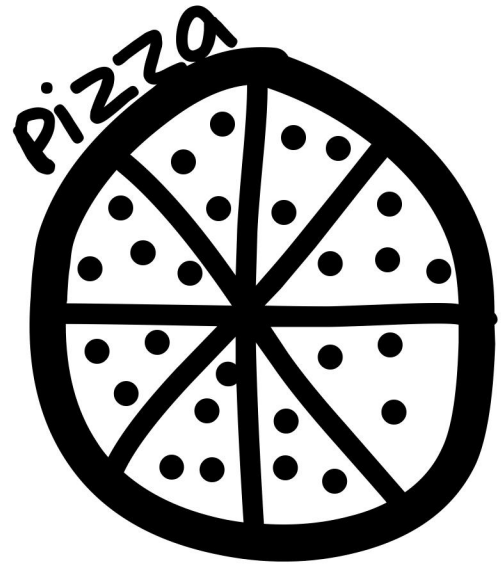
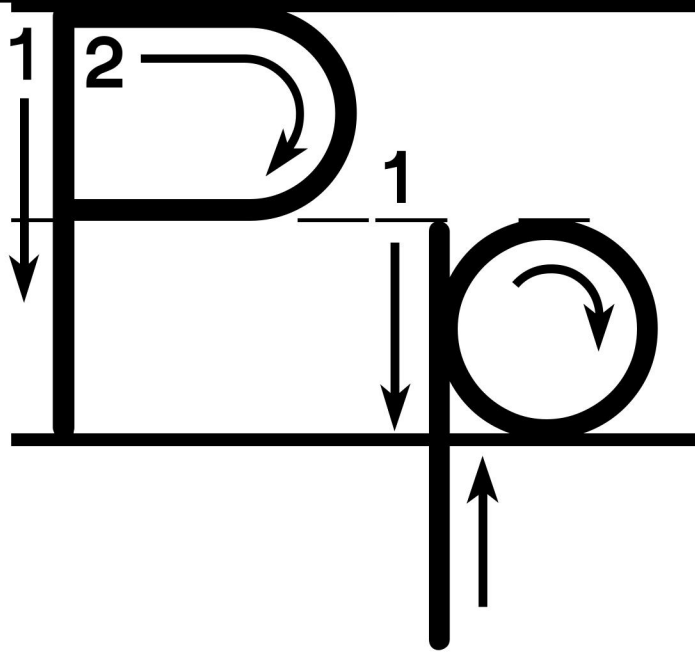

A-Z Letter Formation Tracing

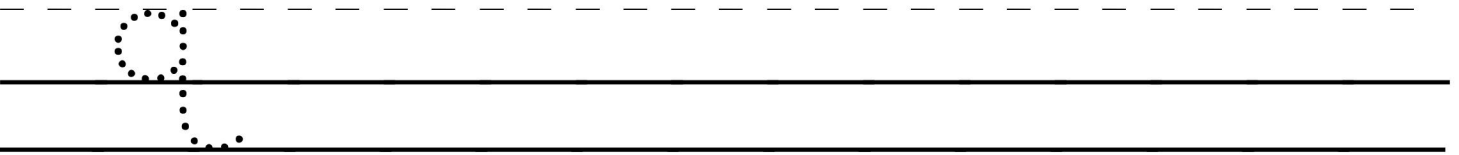
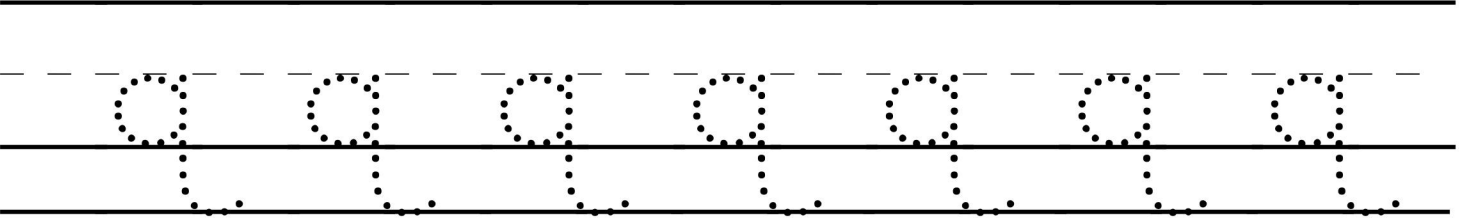
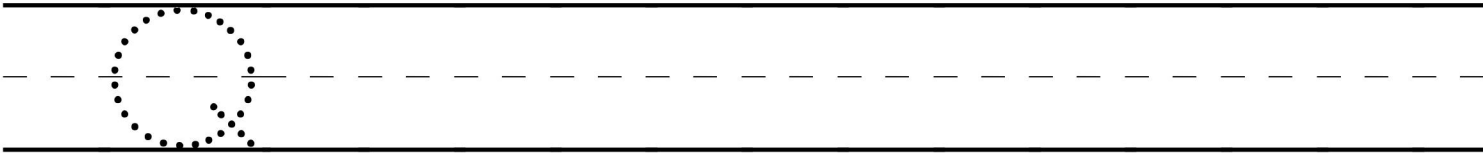
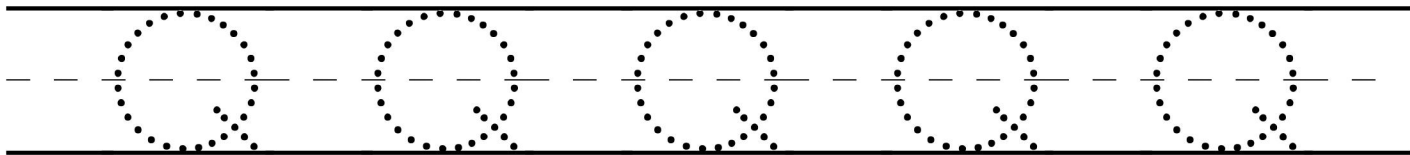
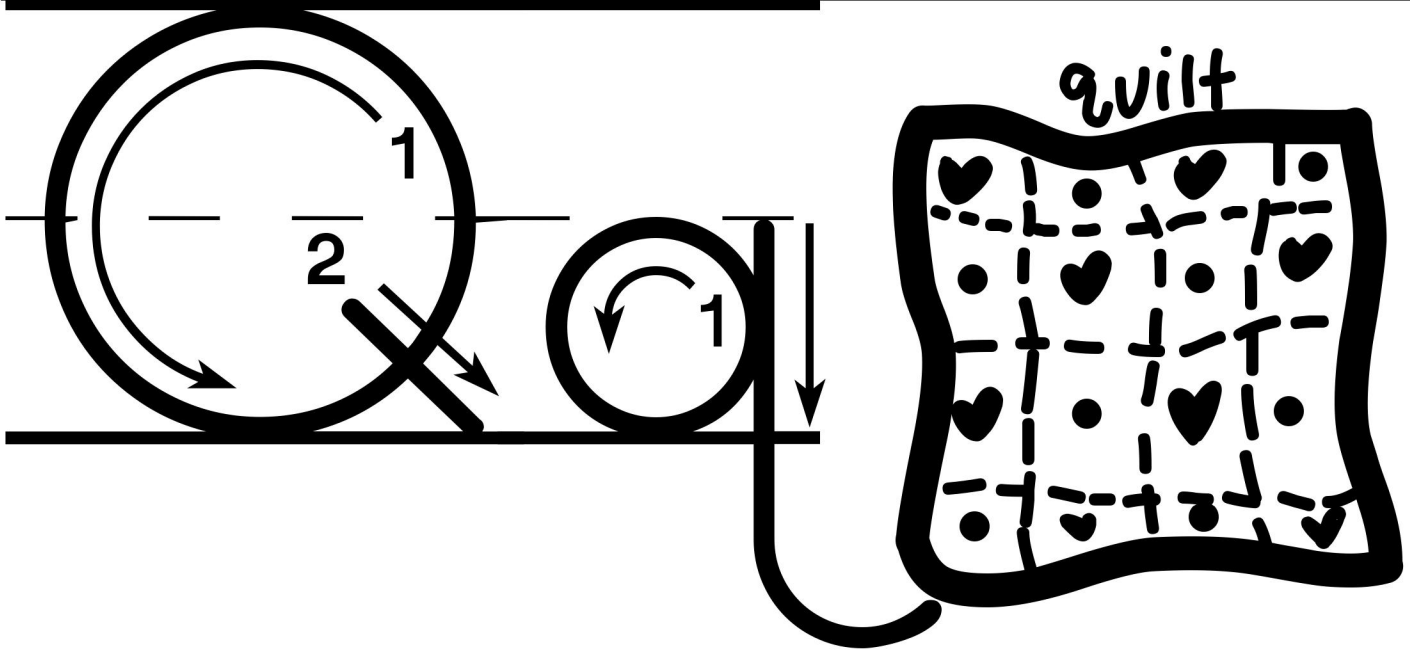

A-Z Letter Formation Tracing

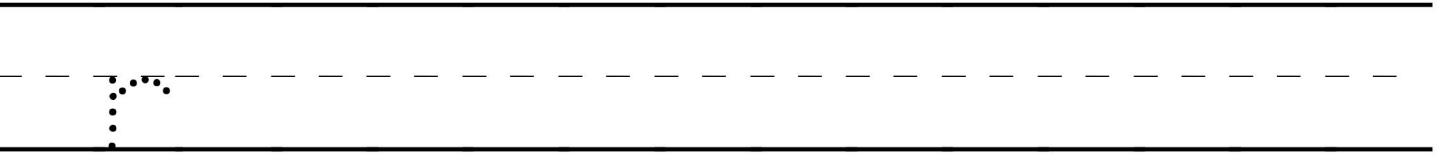
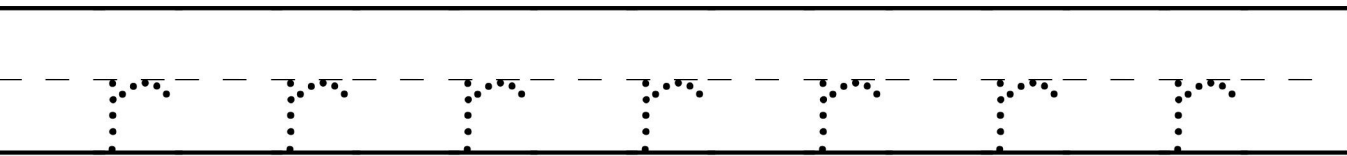
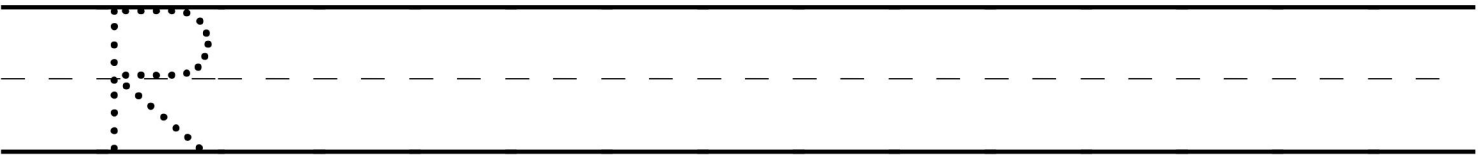
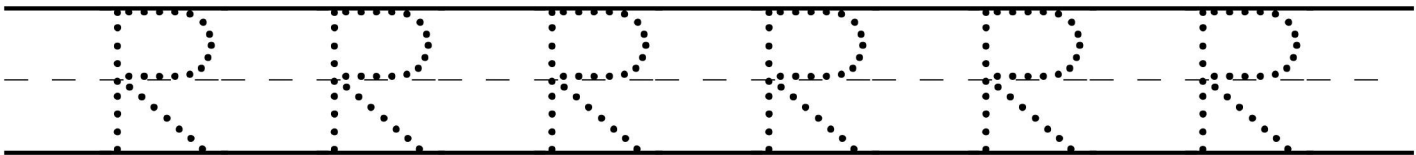
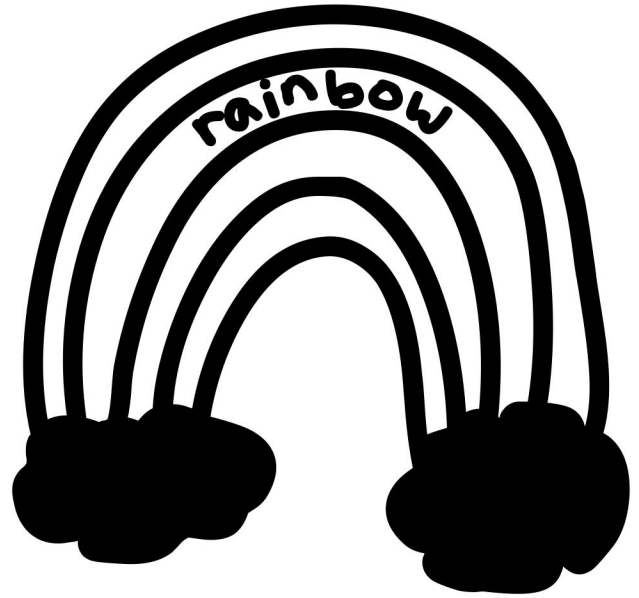
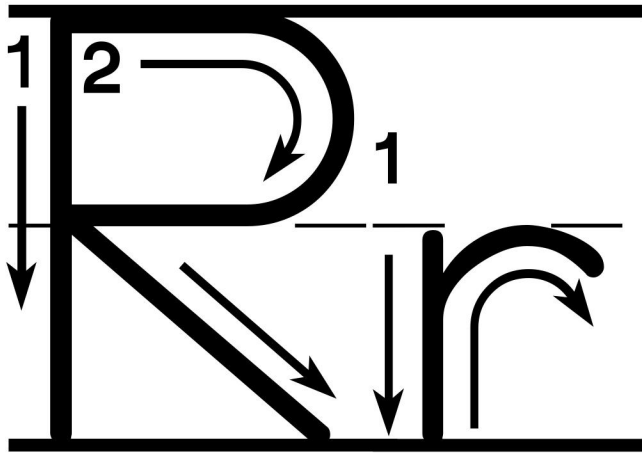

A-Z Letter Formation Tracing

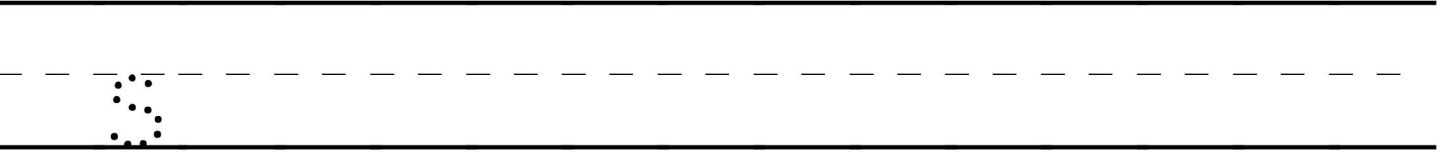
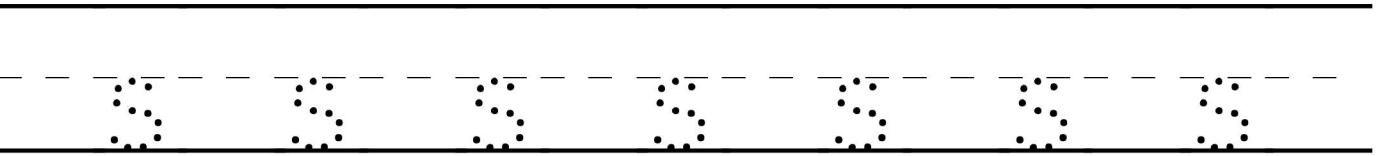
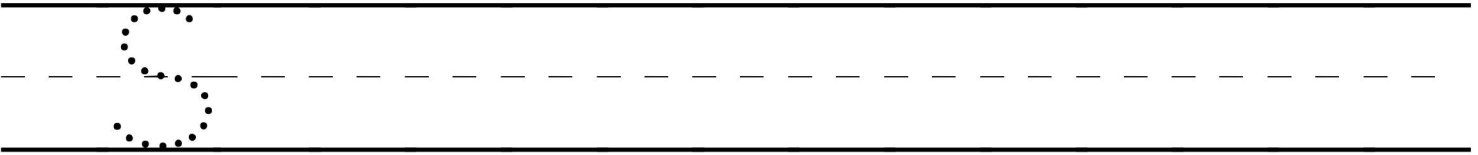
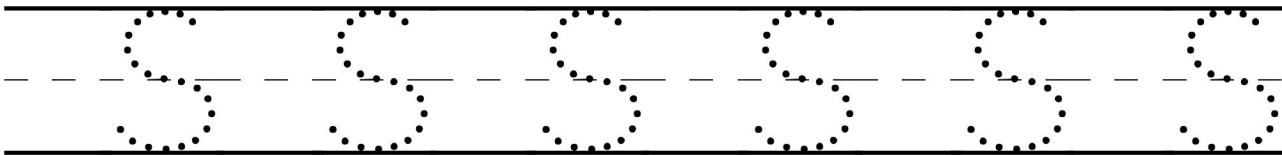
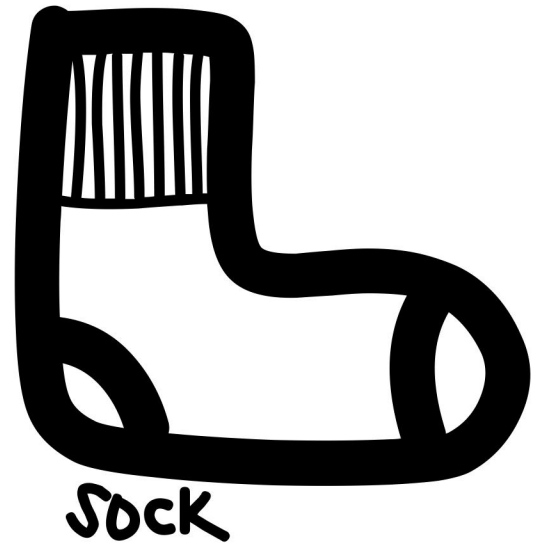
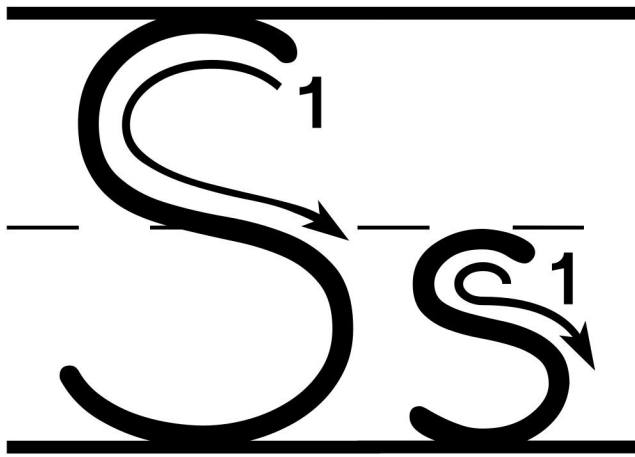

A-Z Letter Formation Tracing

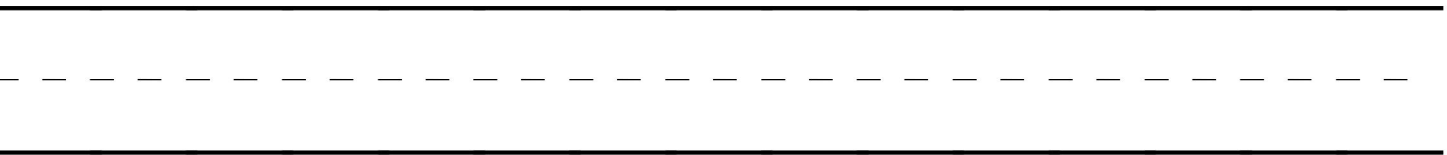
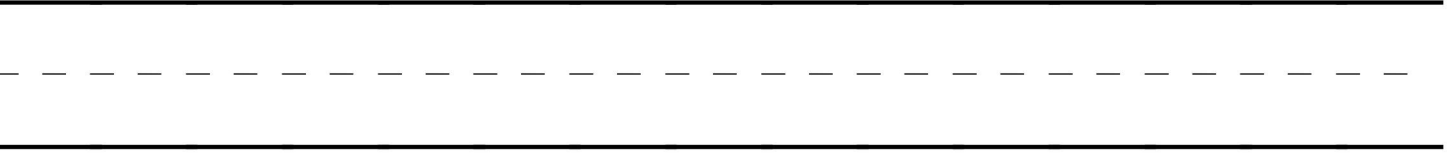
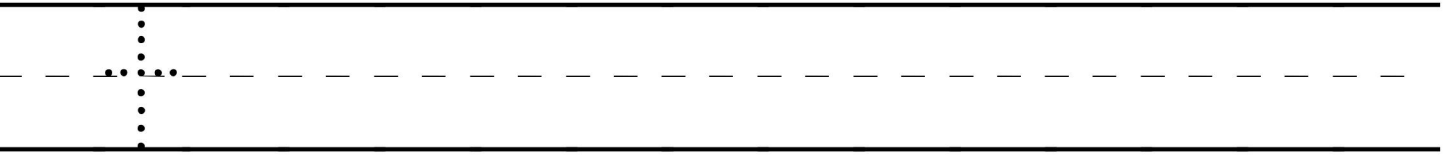
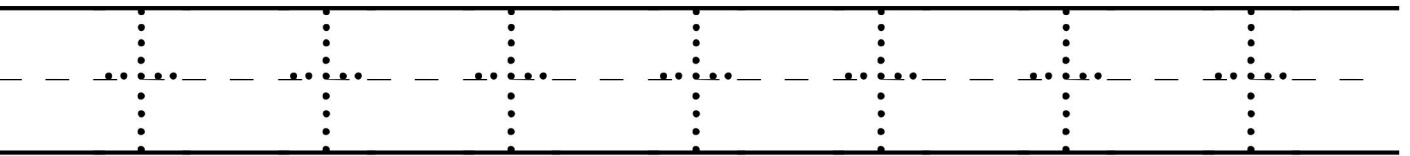
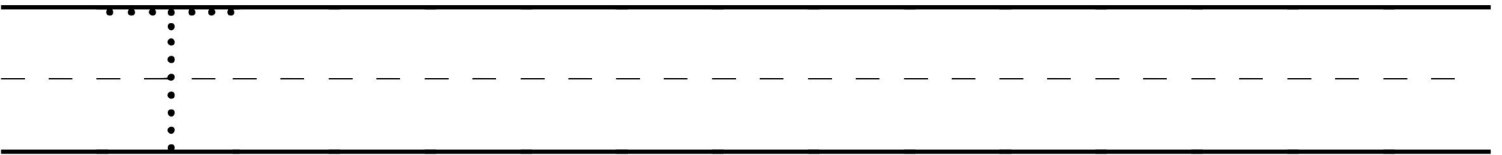
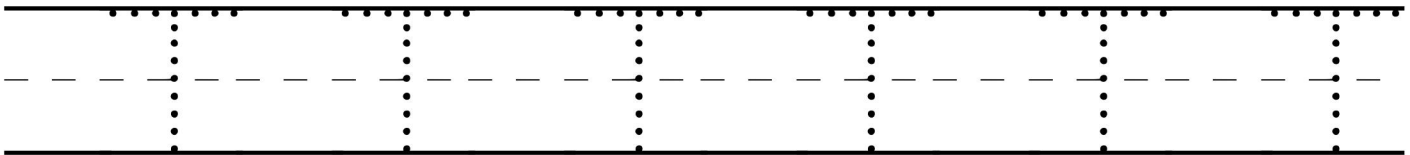
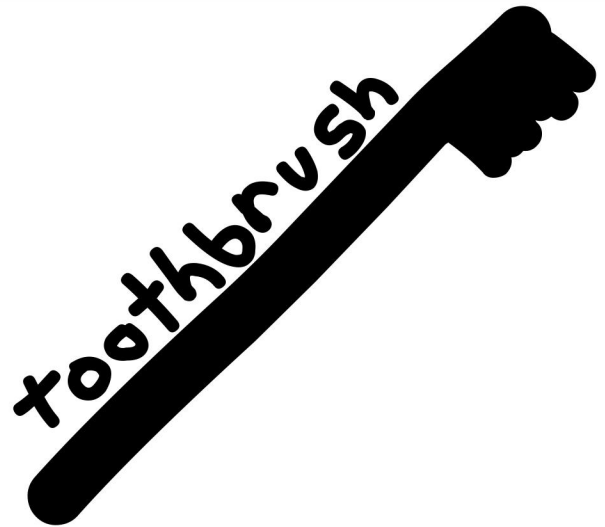
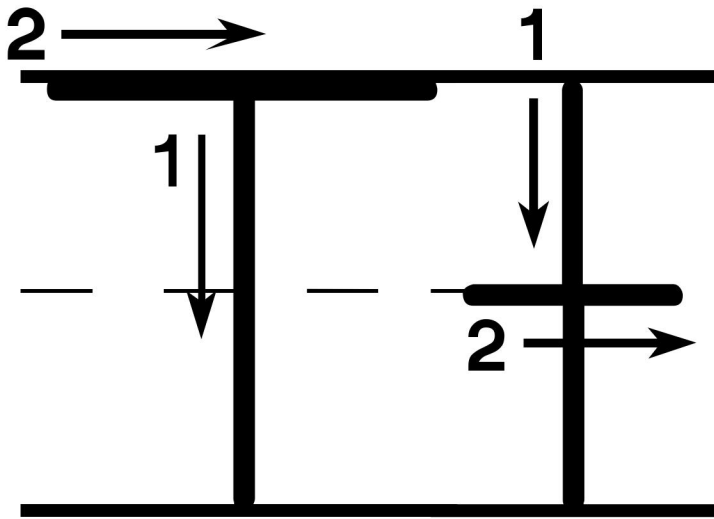

A-Z Letter Formation Tracing

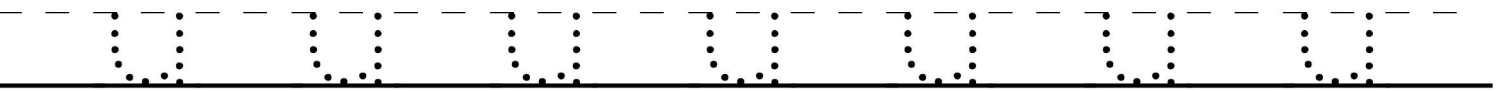
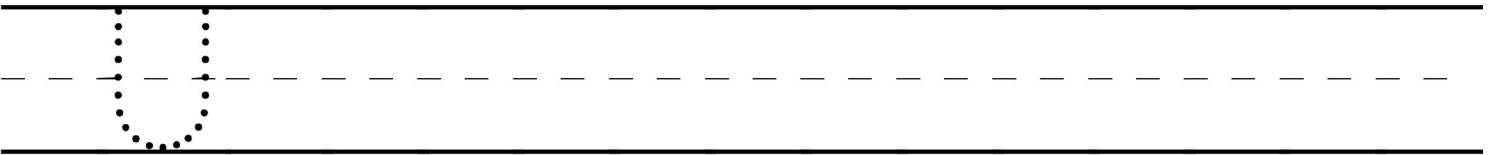
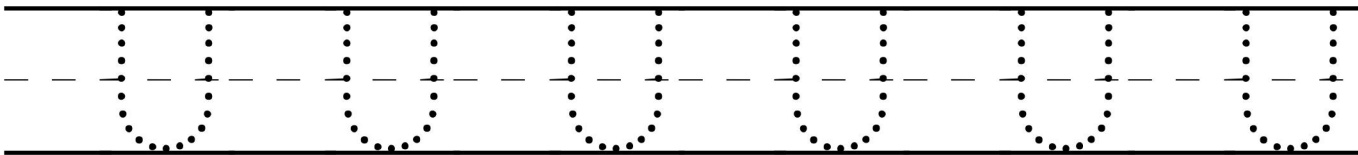
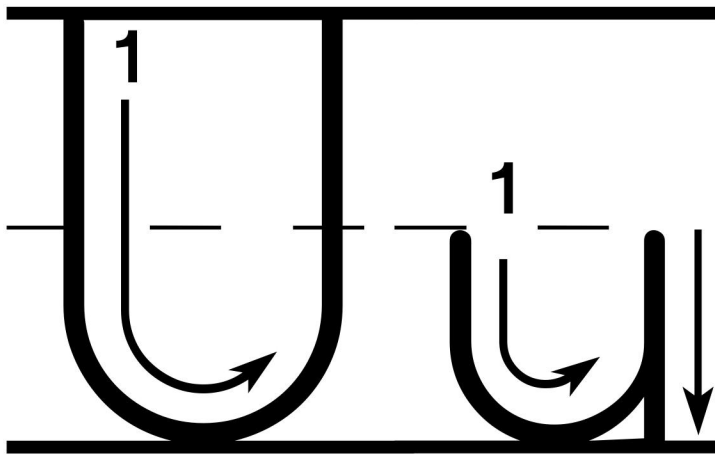

A-Z Letter Formation Tracing

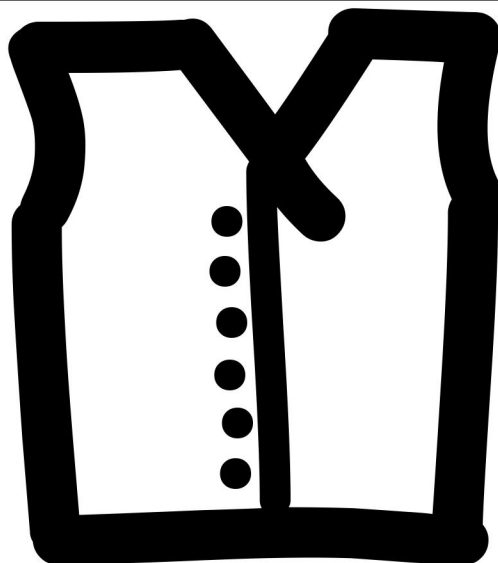
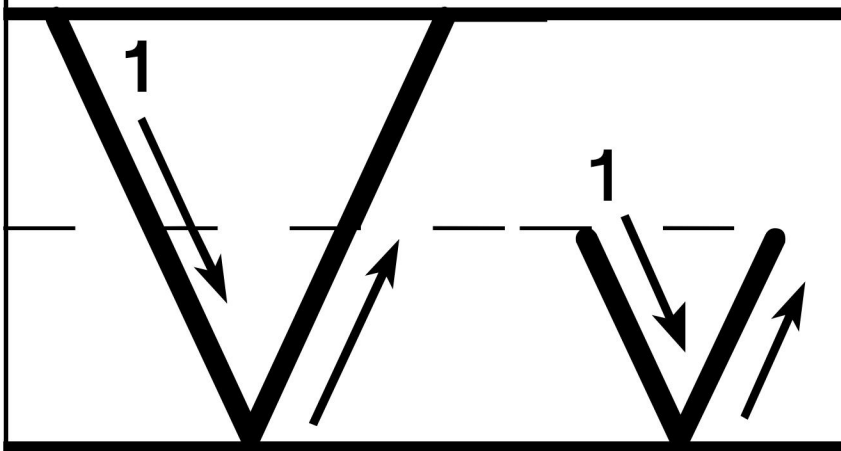

vest

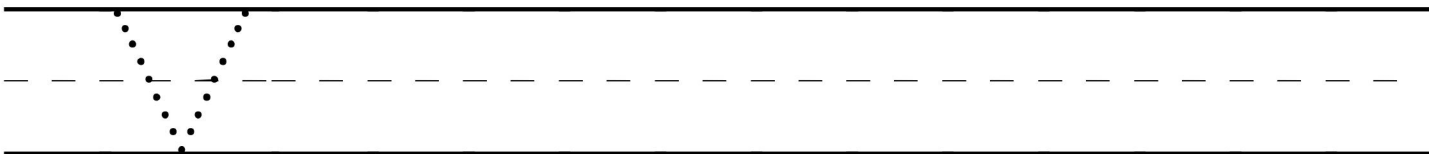
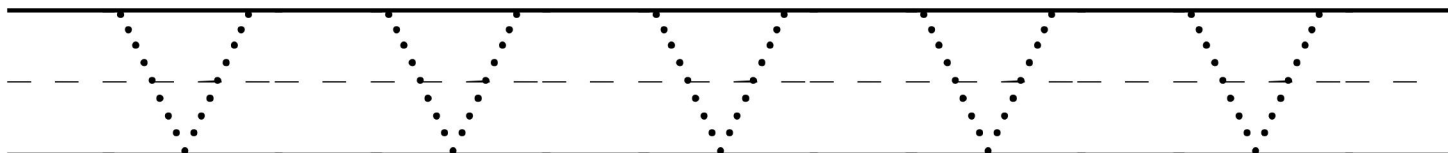

A-Z Letter Formation Tracing

window

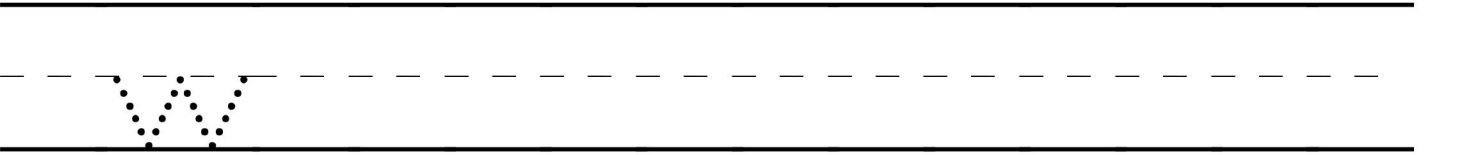
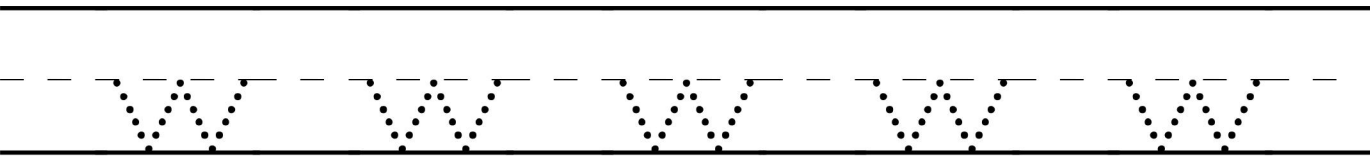
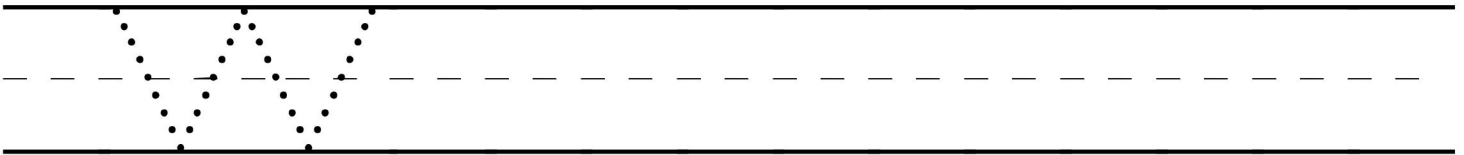
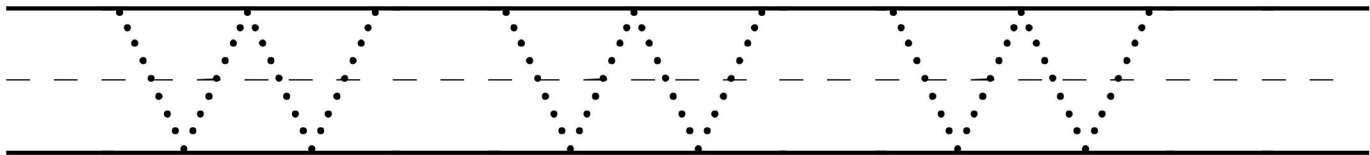
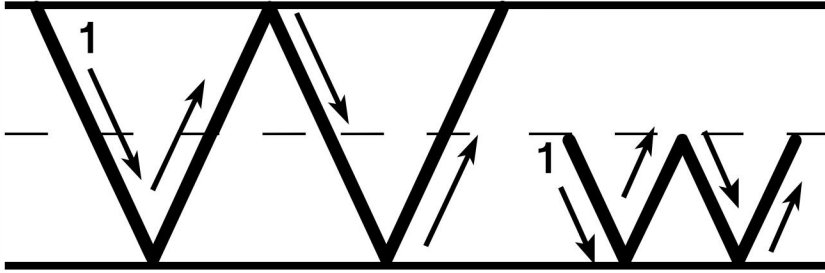
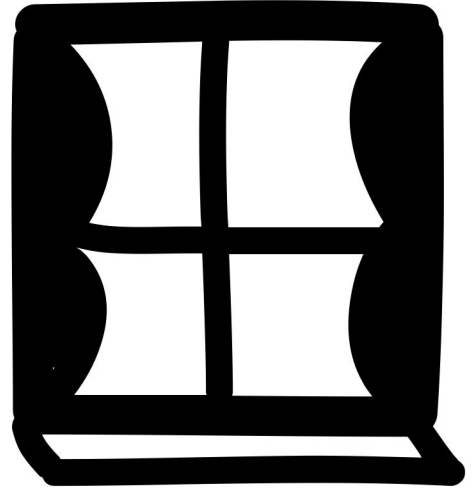

A-Z Letter Formation Tracing

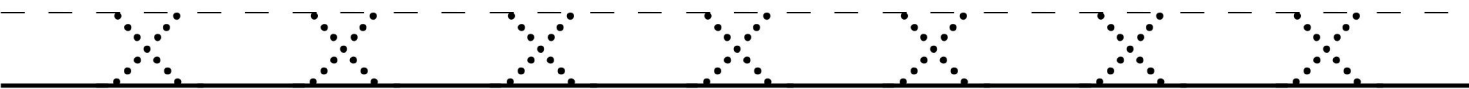
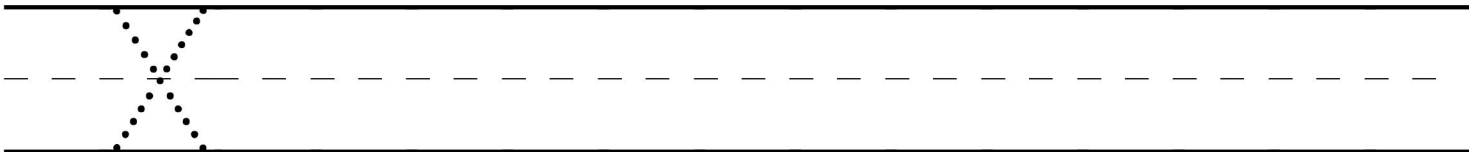
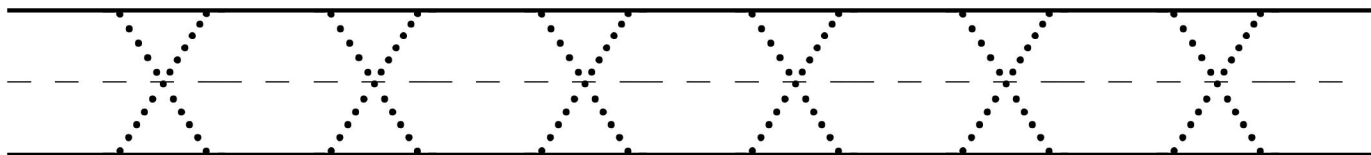
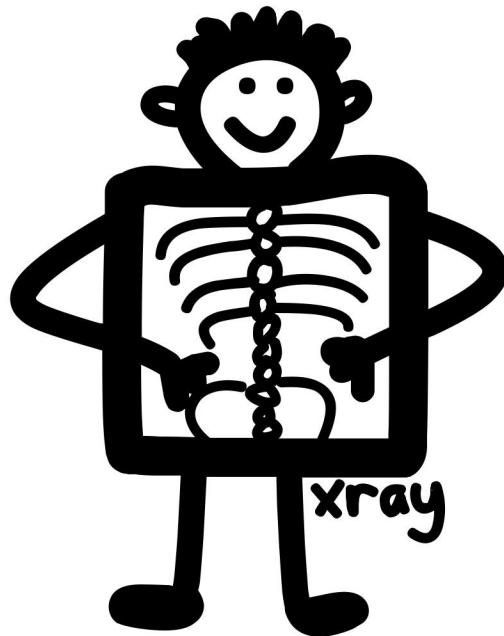
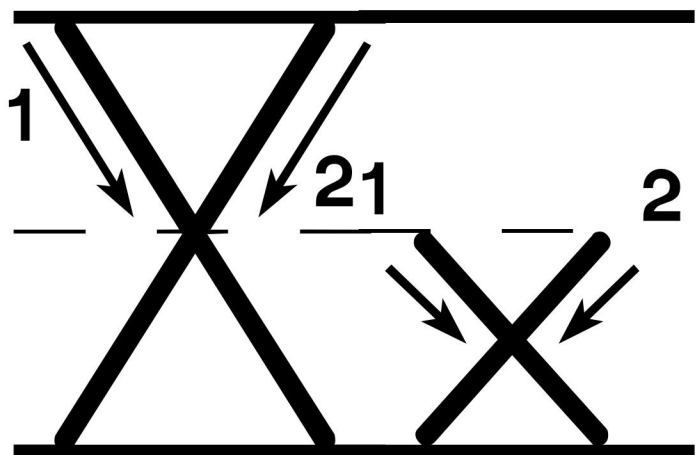

A-Z Letter Formation Tracing

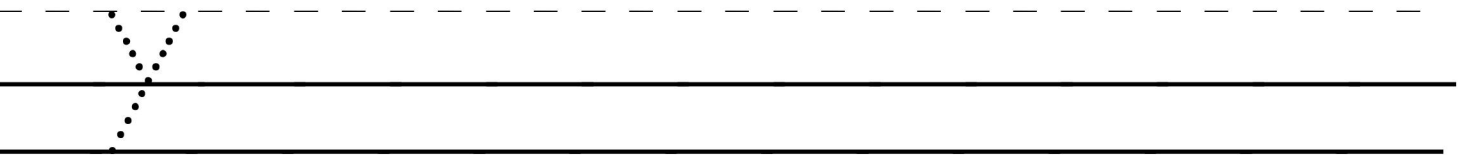
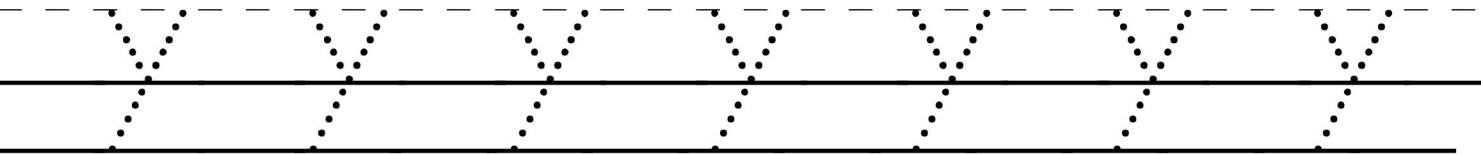
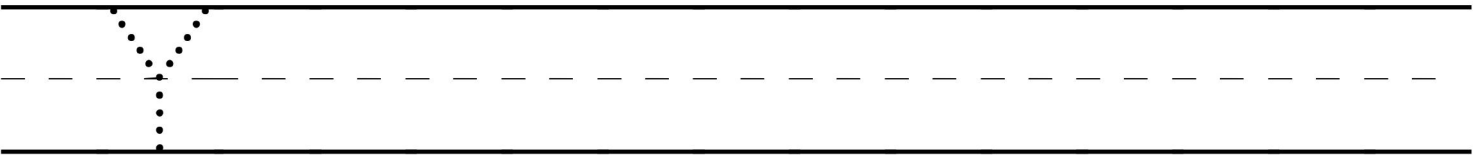
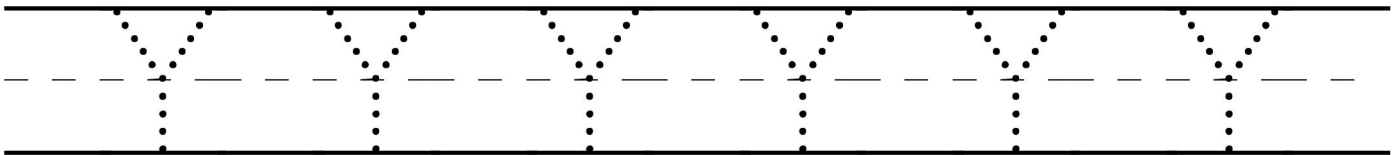
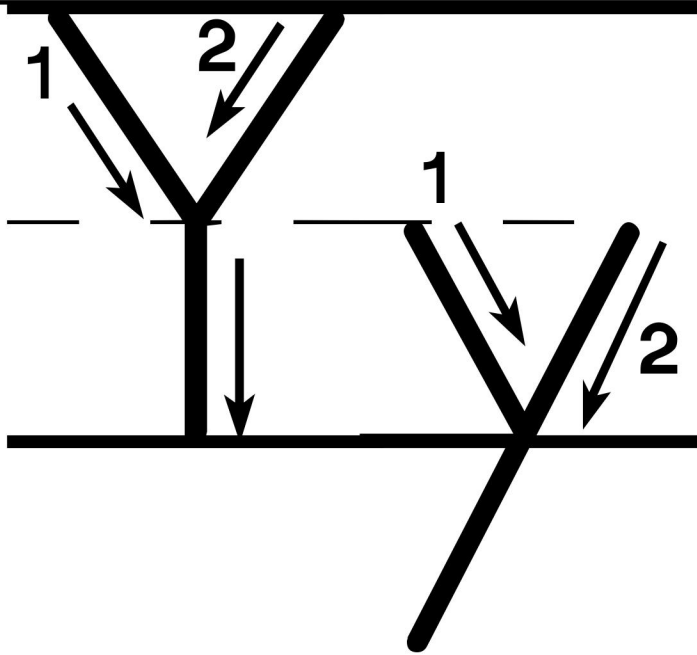

A-Z Letter Formation Tracing

